

Kensington®

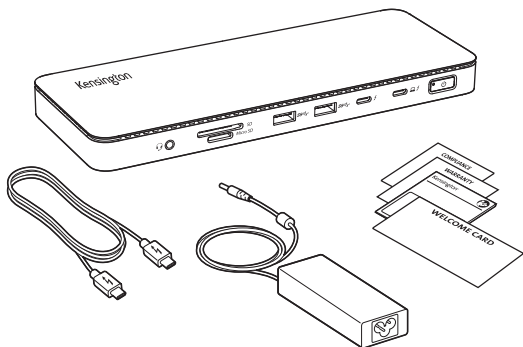

SD5760T Thunderbolt™ 4 Dual 4K Docking Station



US



EU



UK



AU/CN



JP



kensington.com/register

1

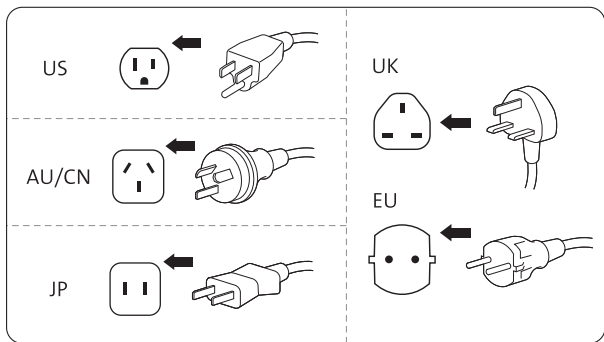
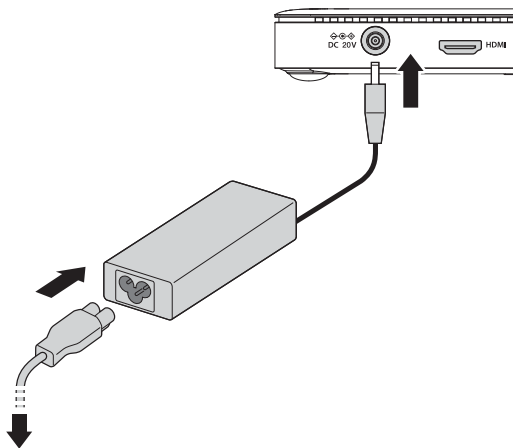

US

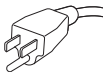

UK



AU/CN



EU

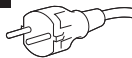

JP



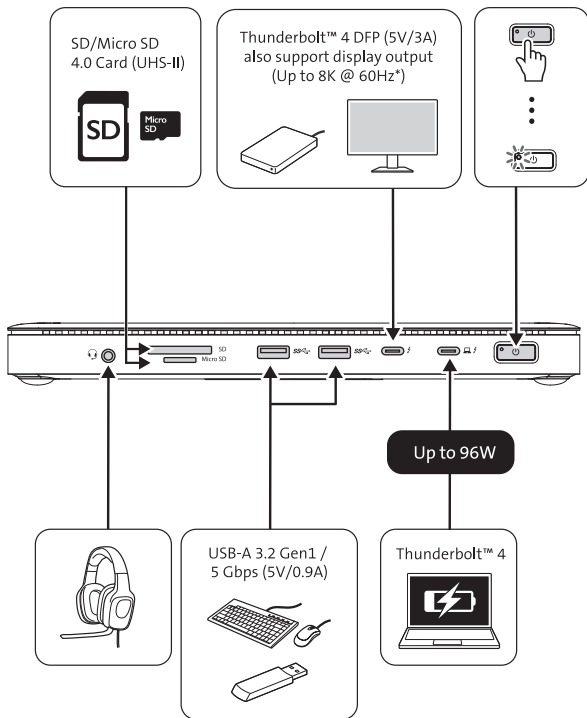

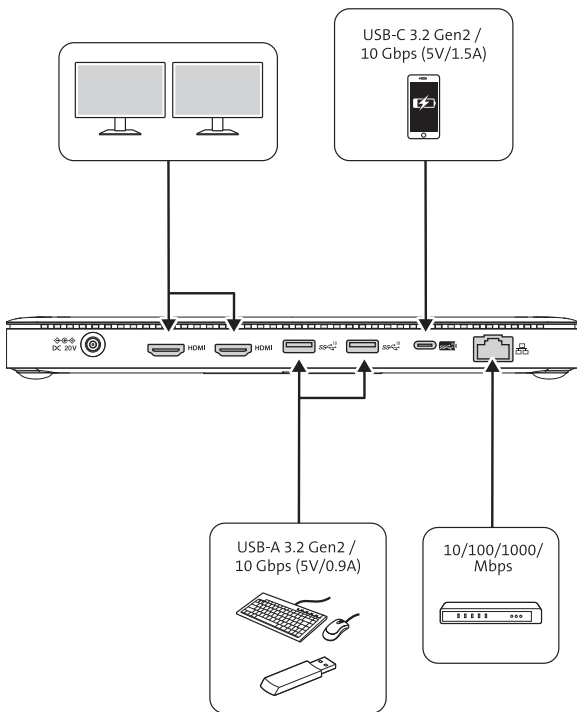



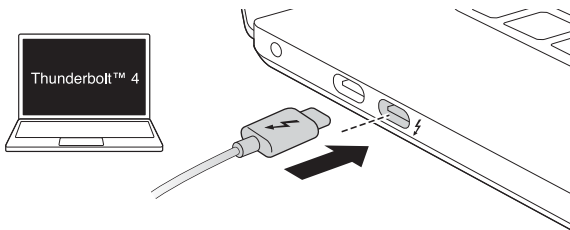



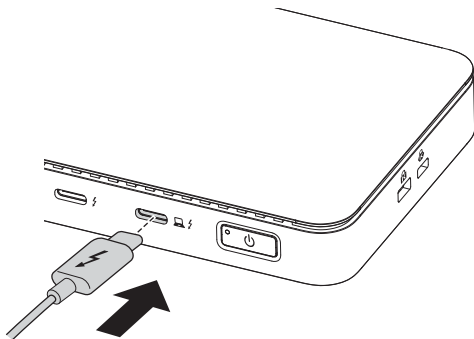

3











4



5

				
	 ⚡	 HDMI	 HDMI	 HDMI +  HDMI
Thunderbolt™ 3 / Thunderbolt™ 4 / USB4 (Windows)	8K @ 60Hz*	4K @ 60Hz	4K @ 60Hz	
Thunderbolt™ 3 / Thunderbolt™ 4 / (macOS)	6K @ 60Hz	4K @ 60Hz	4K @ 60Hz	
USB-C Alt Mode (Windows)	4K @ 60Hz	4K @ 60Hz		
MacBook M1/M2 / iPad Pro	6K @ 60Hz	4K @ 60Hz		

				
	 ⚡	 HDMI	 HDMI	 HDMI +  HDMI
Thunderbolt™ 3 / Thunderbolt™ 4 / USB4 (Windows)	4K up to 120Hz* or 1080p up to 240Hz	1080p up to 240Hz	1080p up to 240Hz	
Thunderbolt™ 3 / Thunderbolt™ 4 / (macOS)				

* Support for Display Stream Compression (DSC) is based on the host device and monitor capabilities.

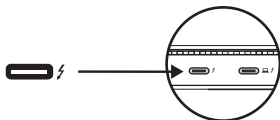

6

Initial Thunderbolt™ 4 connection for Windows

New Thunderbolt™ device have been attached

Thunderbolt™ devices were attached. In order to approve them for use this application must be run with administrator privileges.

Click OK to run the **Thunderbolt™** software with administrator privileges.

OK

Cancel

6.1 Manage Thunderbolt™ 4 devices and settings later



6.2

View Attached Devices
Approve Attached Devices ▸
Manage Approved Device

Settings
Exit



Sold separately

1

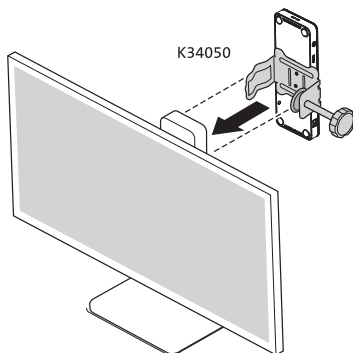

2

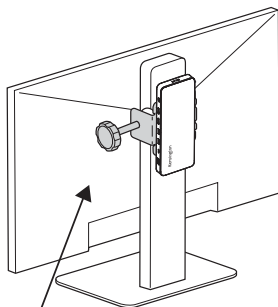

< = 13.2lbs
(< = 6.0kg)

Sold separately

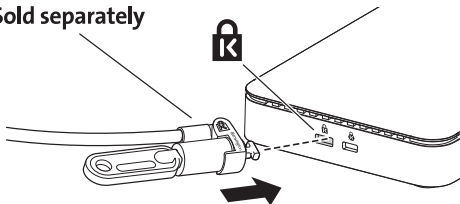

Recommended
K65020WW MicroSaver® 2.0 Keyed Lock

Sold separately

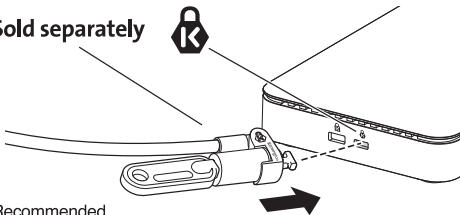

Recommended
K65021WW NanoSaver™ Keyed Laptop Lock

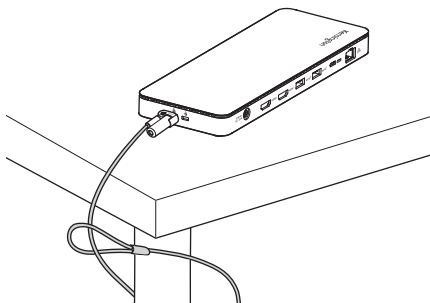



www.kensington.com/support

Kensington® is a registered trademark of ACCO Brands. Windows is a registered trademark of Microsoft Corporation in the U.S. and/or other countries. USB-C is a trademark of USB Implementers Forum. All other trademarks are the property of their respective owners.

©2023 Kensington Computer Products Group, a division of ACCO Brands.

Patents: <https://www.accobrand.com/patents/>

この装置は、クラスB機器です。この装置は、住宅環境で使用することを目的としていますが、この装置がラジオやテレビの受信機に近接して使用されると、受信障害を引き起こすことがあります。

取扱説明書に従って正しい取扱いをして下さい。

VCCI - B

