

Kensington®

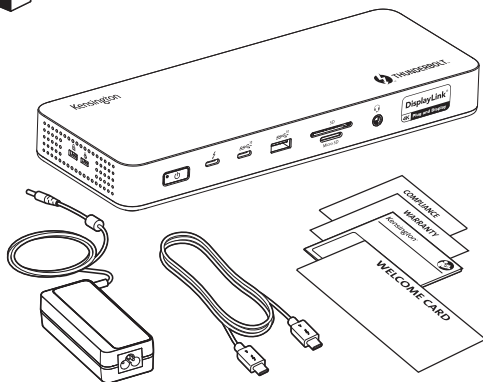

SD5910T EQ Thunderbolt™ 4 Quad 4K Hybrid Dock with DisplayLink® Technology



US



EU



UK



AU/CN



JP



IN



kensington.com/register

1

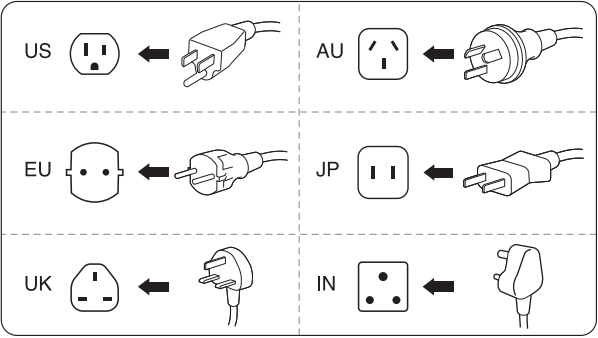
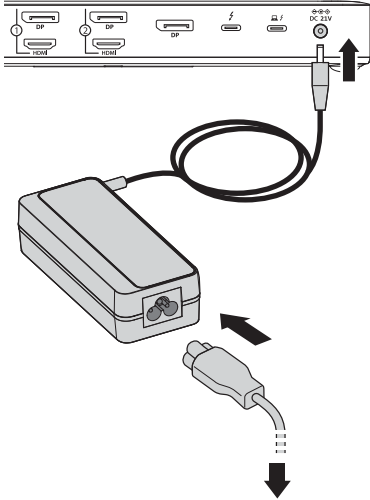

2

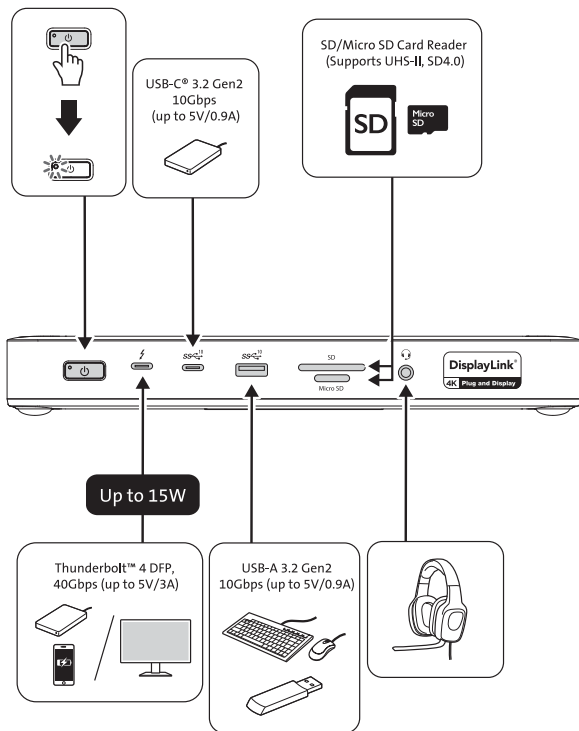

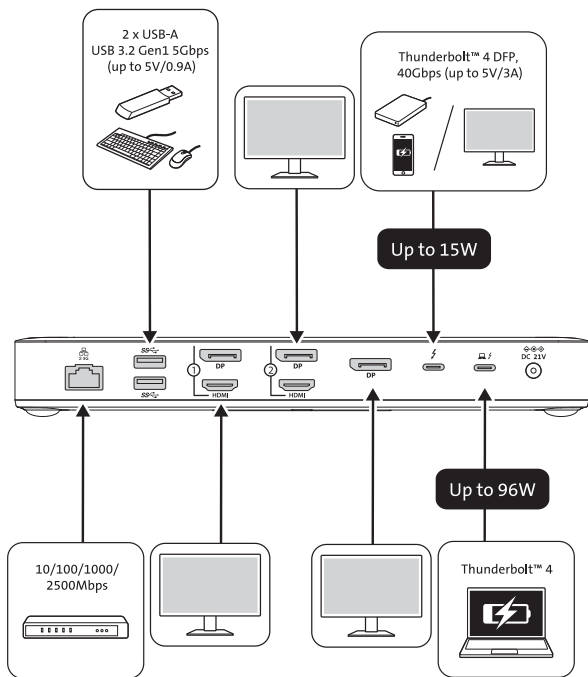

3

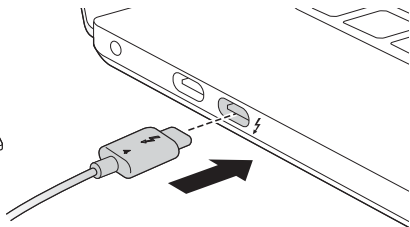
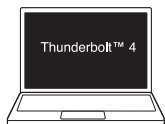

4

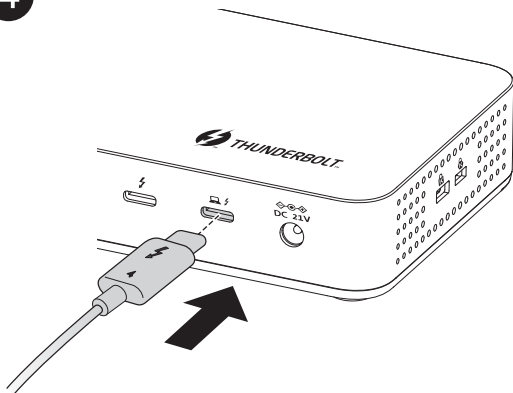

5

a

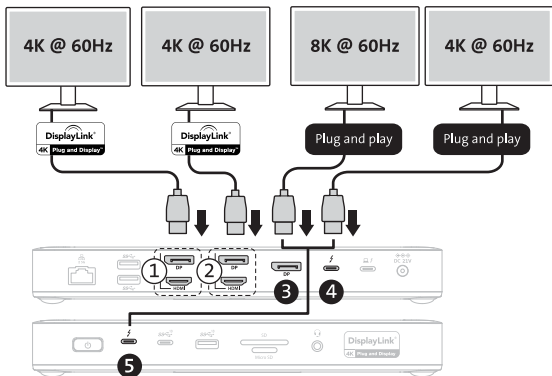

| Video counts | Technology | Note | I/O connection | Video resolution |
|--------------|--------------|------------------------------|----------------|---|
| | DisplayLink® | Driver installation required | ① + ② | Up to 2 x 4K @ 60Hz |
| | Thunderbolt™ | Plug and play | ③ + ④ | 1 x 8K @ 60Hz (Thunderbolt™ laptop) + 1 x 4K @ 60Hz |
| | | | ④ + ⑤ | |
| | | | ⑤ + ③ | |

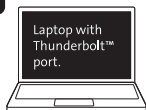
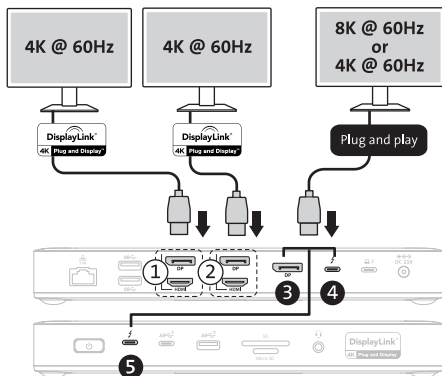
b**or**

| Video counts | Technology | Note | I/O connection | Video resolution |
|--------------|--------------|------------------------------|----------------|--|
| | DisplayLink® | Driver installation required | ① + ② | Up to 2 x 4K @ 60Hz |
| | Thunderbolt™ | Plug and play | ③ | 1 x 8K @ 60Hz (Thunderbolt™ laptop) or 1 x 4K @ 60Hz (USB-C® Alt Mode laptop) |
| | | | ④ | |
| | | | ⑤ | |

5

c

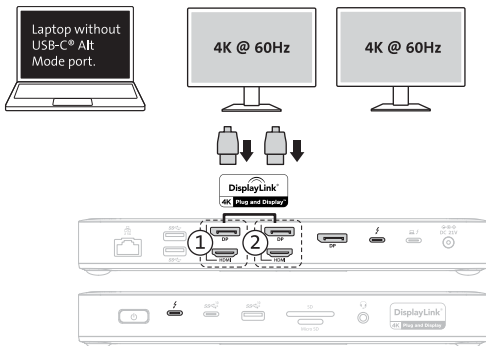
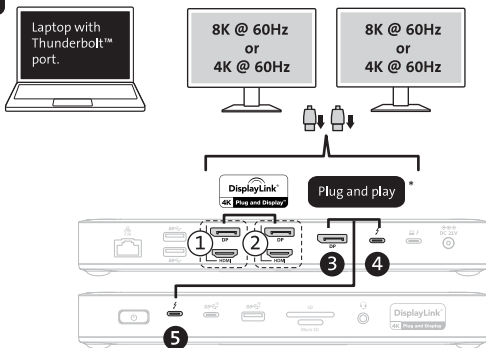

| Video counts | Technology | Note | I/O connection | Video resolution |
|---|-----------------------------|--|----------------|--|
|  | DisplayLink® | Driver installation required (Recommended**) | ① + ② | Up to 2 x 4K @ 60Hz |
| | Thunderbolt™ | Plug and play (Focus on high-resolution) | ③ + ④* | 1 x 8K @ 60Hz (Thunderbolt™ laptop) + 1 x 4K @ 60Hz |
| | | | ④ + ⑤* | |
| | | | ③ + ⑤* | |
| | DisplayLink® + Thunderbolt™ | Driver installation required | ① + ③ | 1 x 8K @ 60Hz (Thunderbolt™ laptop) + 1 x 4K @ 60Hz |
| | | | ① + ④ | |
| ① + ⑤ | | | | |

*USB-C® Alt Mode laptops do not support dual plug-and-play displays; connect to at least one DisplayLink® port to achieve dual displays.

| Video counts | Technology | Note | I/O connection | Video resolution |
|---|--------------|------------------------------|----------------|-------------------------------------|
|  | Thunderbolt™ | Plug and play | ③ | 1 x 8K @ 60Hz (Thunderbolt™ laptop) |
| | | | ④ | |
| | | | ⑤ | |
| | DisplayLink® | Driver installation required | ① | Up to 1 x 4K @ 60Hz |
| | | | ② | |

DE *Laptops mit USB-C® Alt Mode unterstützen keine dualen Plug-and-Play-Displays; zur Unterstützung dualer Displays mit mindestens einem DisplayLink®-Anschluss verbinden.

FR *Les ordinateurs portables USB-C® Alt Mode ne prennent pas en charge deux écrans en plug-and-play ; connectez au moins un port DisplayLink® pour utiliser deux écrans.

IT *USB-C® I portatili Alt Mode non supportano due display plug-and-play; collegare ad almeno una porta DisplayLink® per poter utilizzare due display.

ES *USB-C® Los portátiles Alt Mode no admiten doble pantalla plug-and-play; conéctelos al menos a un puerto DisplayLink® para conseguir doble pantalla.

PT *Os computadores portáteis Alt Mode USB-C® não suportam ecrãs duplos plug-and-play; ligue a pelo menos uma porta DisplayLink® para obter ecrãs duplos.

CN *USB-C® Alt 模式笔记本电脑不支持双即插即用显示器。至少需要连接一个 DisplayLink® 端口，以连接双显示器。

JP *USB-C® Alt モードのノート PC の場合、2画面での Plug&Play に対応していません。1画面以上で DisplayLink®ポートに接続した場合、デュアルディスプレイにすることができます。

AE *لا تدعم أجهزة الكمبيوتر المحمولة المزودة بوضع USB-C® Alt شاشات العرض المزدوجة التي تعمل بمجرد التوصيل؛ يلزم الاتصال بمنفذ DisplayLink® واحد على الأقل للحصول على العرض المزدوج.

Sold separately

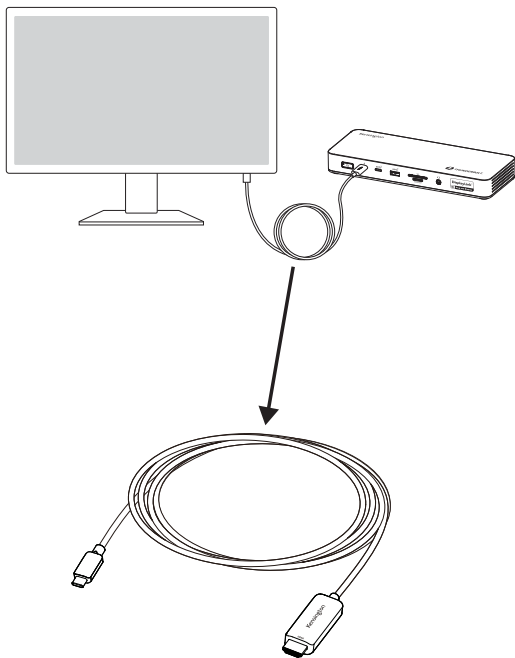

Recommended:
K38343WW USB-C® to HDMI® Unidirectional 8K Cable (M/M)
for Monitor Display.

Sold separately

1

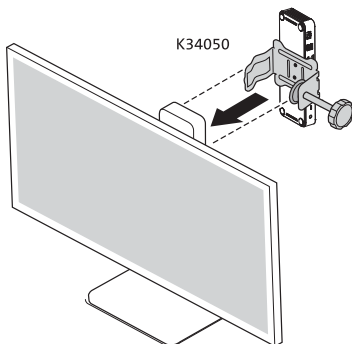

2

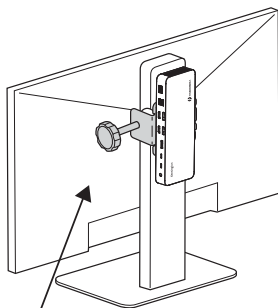

**< = 13.2lbs
(< = 6.0kg)**

Sold separately

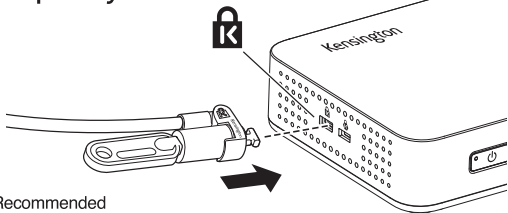

Recommended
K65020WW MicroSaver® 2.0 Keyed Lock

Sold separately

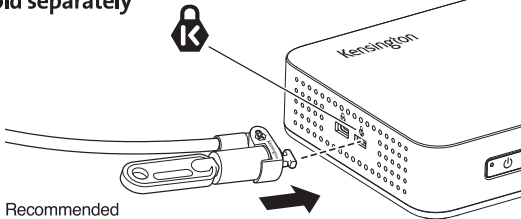

Recommended
K65021WW Slim NanoSaver® 2.0 Keyed Laptop Lock

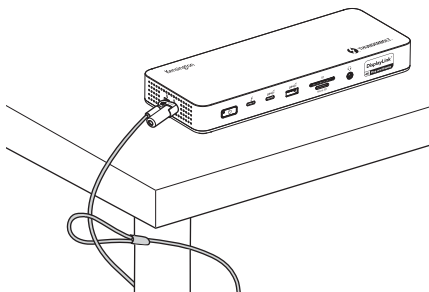



www.kensington.com/support

Kensington® is a registered trademarks of ACCO Brands. Windows is a registered trademark of Microsoft Corporation in the U.S. and/or other countries.USB-C® is a trademark of USB Implementers Forum. Thunderbolt and the Thunderbolt logo are trademarks of Intel Corporation in the U.S. and/or other countries. DisplayLink® is a registered trademark of DisplayLink Corp. HDMI® is a registered trademark of HDMI Licensing Administrator, Inc. All other registered and unregistered trademarks are the property of their respective owners.
© 2024 Kensington Computer Products Group, a division of ACCO Brands.
Patents: <https://www.accobrand.com/patents/>



K35233

901-7482-00