

# Kensington®

## SafeDock™

### MacBook Air® Security Dock & Lock

INSTRUCTION GUIDE  
GUIDE D'INSTRUCTIONS  
BEDIENUNGSANLEITUNG  
HANDLEIDING  
MANUALE DI ISTRUZIONI  
MANUAL DE INSTRUCCIONES

HASZNÁLATI ÚTMUTATÓ  
PŘÍRUČKA S POKYNY  
INSTRUKCJA OBSŁUGI  
РУКОВОДСТВО ПОЛЬЗОВАТЕЛЯ  
MANUAL DE INSTRUÇÕES

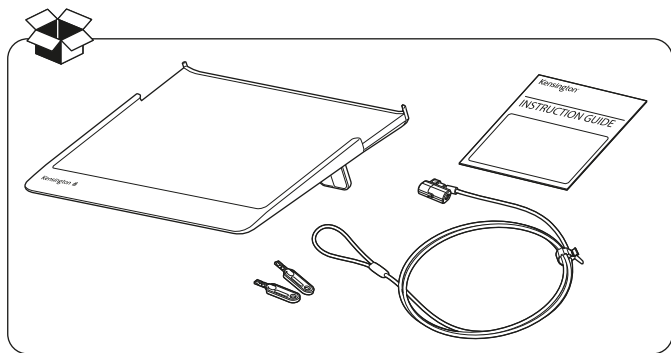

**Register Now!**  
Enregistrer maintenant !  
Jetzt registrieren!  
Nu registreren  
Registrar ahora  
Registra adesso

**Regisztráljon most!**  
Zaregistrujte se nyní!  
Zarejestruj się!  
Зарегистрироваться!  
Registe-se agora!

[register.kensington.com](http://register.kensington.com)

1

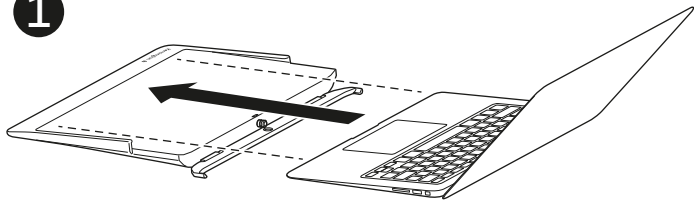

2 a

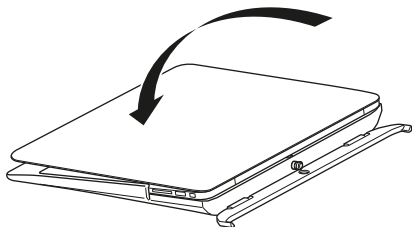

⋮

b

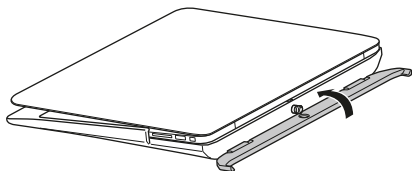

⋮

c

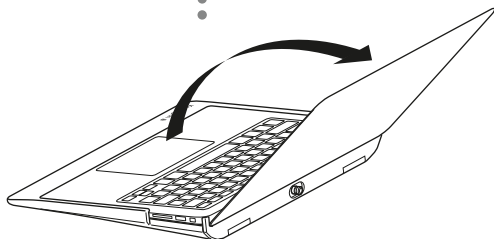

**1**

Locking / Verrouillage / Abschließen / Vergrendelen /  
Blocco / Bloqueo / Zárás / Uzamknutí / Blokowanie /  
Блокировка / Bloqueio

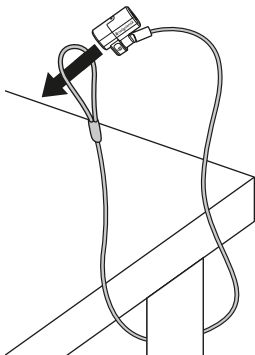
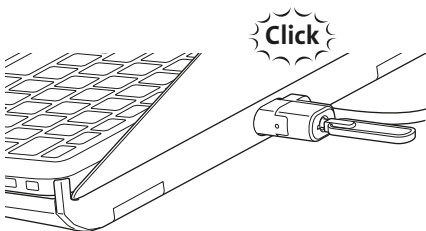
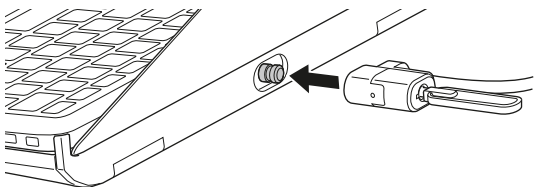
**2**

3

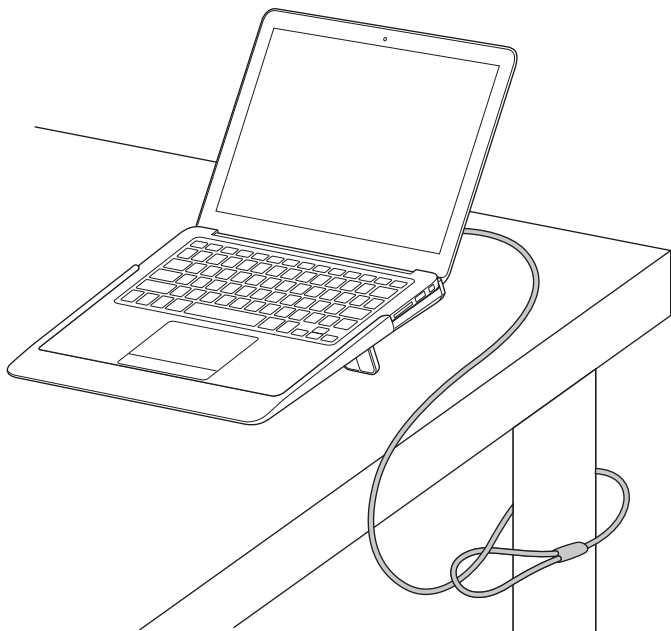



**IMPORTANT! REGISTER YOUR COMBINATION! /  
IMPORTANT ! ENREGISTREZ VOTRE COMBINAISON !  
WICHTIG! REGISTRIEREN SIE IHRE KOMBINATION!  
BELANGRIJK! REGISTREER UW COMBINATIE!  
IMPORTANTE! REGISTRARE LA COMBINAZIONE!  
IMPORTANTE: ;REGISTRE SU COMBINACIÓN!  
FONTOS! REGISZTRÁLJA A KOMBINÁCIÓJÁT!  
DŮLEŽITÉ! ZAREGISTRUJTE SI SVOU KOMBINACI!  
UWAGA! ZMIENÍ SWÓJ SZYFR!  
ВАЖНО! КОДОВАЯ КОМБИНАЦИЯ ДОЛЖНА БЫТЬ  
ЗАРЕГИСТРИРОВАНА!  
IMPORTANTE! REGISTRE A SUA COMBINAÇÃO!**

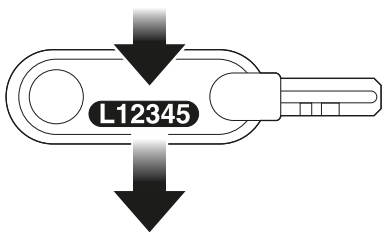

**[register.kensington.com](https://register.kensington.com)**

**#**

--	--	--	--	--	--

Kensington and the ACCO name and design are registered trademarks of ACCO Brands. The Kensington Promise is a service mark of ACCO Brands. SafeDock and ClickSafe are trademarks of ACCO Brands. MacBook Air is a trademark of Apple Inc., registered in the U.S. and other countries. All other registered and unregistered trademarks are the property of their respective owners. Covered by one or more of US Pat. No's 6,081,974; 6,317,936; 6,360,405.

©2012 Kensington Computer Products Group, a division of ACCO Brands. Any unauthorized copying, duplicating, or other reproduction of the contents hereof is prohibited without written consent from Kensington Computer Products Group. All rights reserved. 07/12



LIMITED LIFETIME  
**WARRANTY**  
GARANTIE  
À VIE LIMITÉE

For technical support visit:  
Pour tout support  
technique veuillez visiter:

[www.kensington.com](http://www.kensington.com)



*The Kensington Promise*<sup>SM</sup>

Complete warranty terms are available at:

[www.warranty.kensington.com](http://www.warranty.kensington.com)

**Kensington Computer  
Products Group**  
A Division of ACCO Brands  
333 Twin Dolphin Drive,  
6th Floor  
Redwood Shores, CA 94065

**ACCO Brands Europe**  
Oxford House  
Oxford Road  
Aylesbury  
Bucks, HP21 8SZ  
United Kingdom

**ACCO Brands Canada**  
5 Precidio Court  
Brampton  
Ontario, L6S 6B7  
Canada

**ACCO Australia**  
Level 2, 8 Lord St  
Botany NSW 2019  
PO Box 311  
Rosebery NSW 1445  
Australia

901-2636-00

KL