

# Kensington®

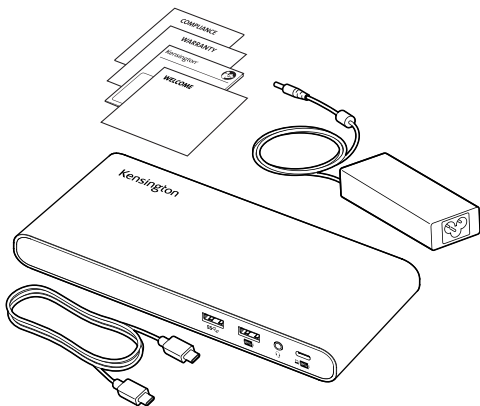

## SD4810P USB-C Triple Video Driverless Dock



US



EU

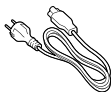

UK



AU/CN



JP



[kensington.com/register](https://www.kensington.com/register)

1

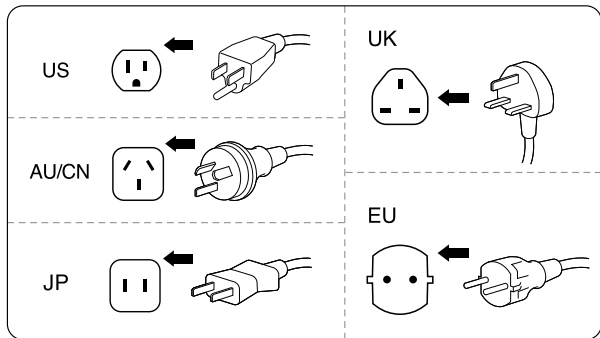
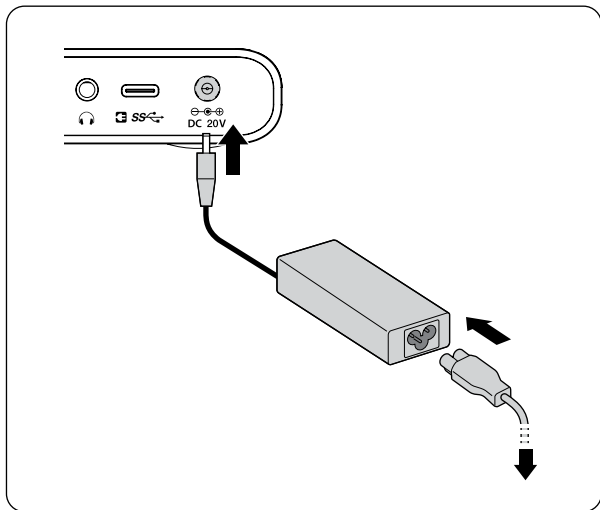

2

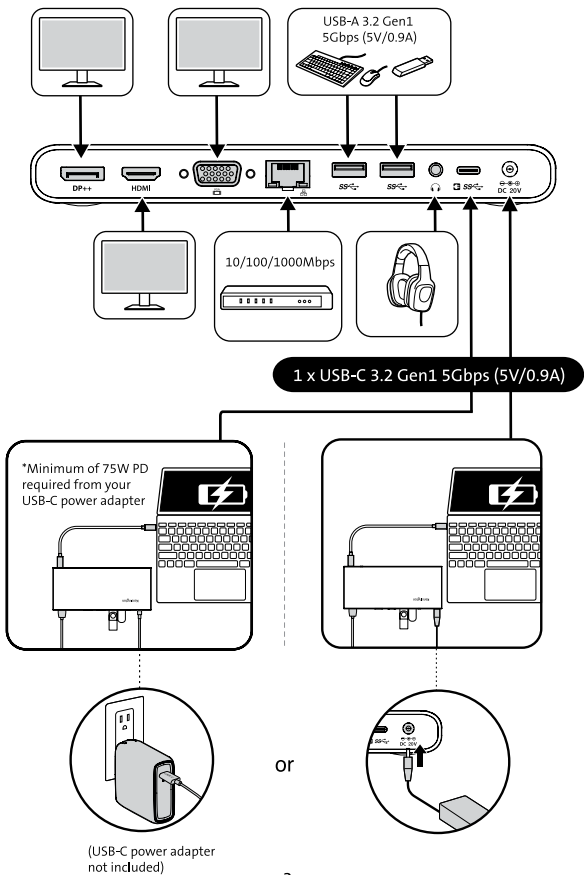

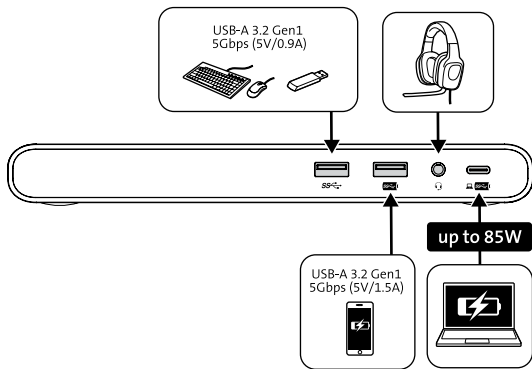

- EN** \*Minimum of 75W PD required from your USB-C power adapter.
- DE** \*Mindestens 75 W PD von Ihrem USB-C-Netzteil erforderlich.
- FR** \*Votre adaptateur d'alimentation USB-C doit fournir une puissance minimale de 75 W.
- IT** \*Erogazione di potenza minima richiesta dall'adattatore di alimentazione USB-C: 75 W.
- ES** \*Se requiere un adaptador de corriente USB-C de mínimo 75 W de potencia.
- PT** \*Mínimo de 75 W PD necessário do seu adaptador de alimentação USB-C.
- AE** \*يلزم توفر 75W PD بحد أدنى من محول طاقة USB-C لديك\*
- CN** \*您的 USB-C 电源适配器至少需要提供 75W 的输出功率。
- JP** \*USB-C 電源アダプターから 75W 以上の電力供給が求められます。

3

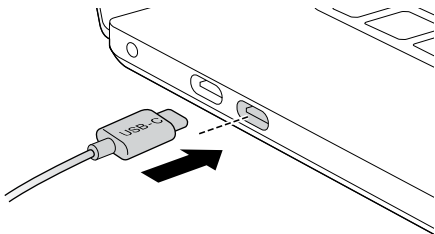
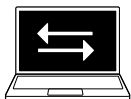



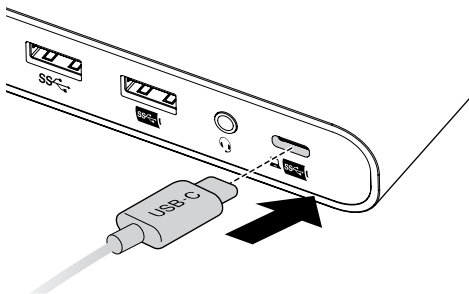





4







# 5



		
		
HBR2/ HBR3	Single 4K (3840 x 2160) @ 30Hz	Single 1080p (1920 x 1080) @ 60Hz

			
			
HBR2/ HBR3	Dual 1080p (1920 x 1080) @ 60Hz		

			
	 		
HBR2/ HBR3	Single 1080p (1920 x 1080) @ 60Hz + Dual 720p (1280 x 720) @ 60Hz		

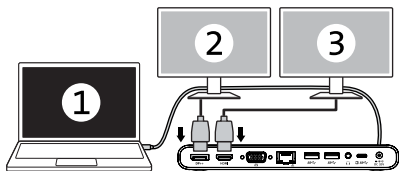
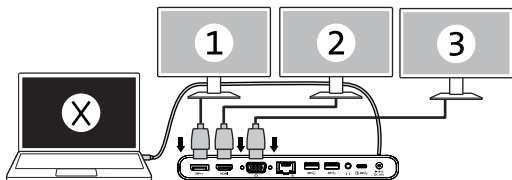
**a****b**



[www.kensington.com/support](http://www.kensington.com/support)

Kensington and ACCO are registered trademarks of ACCO Brands. Windows is a registered trademark of Microsoft Corporation in the U.S. and/or other countries. USB-C is a trademark of USB Implementers Forum. All other trademarks are the property of their respective owners. ©2022 Kensington Computer Products Group, a division of ACCO Brands.

