

# Kensington®

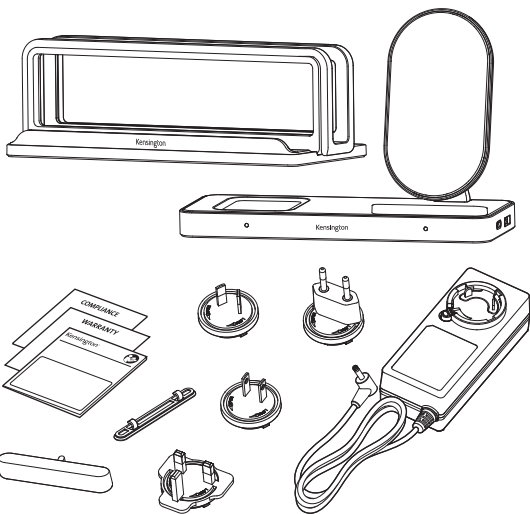

StudioCaddy™



[kensington.com/register](https://kensington.com/register)

1

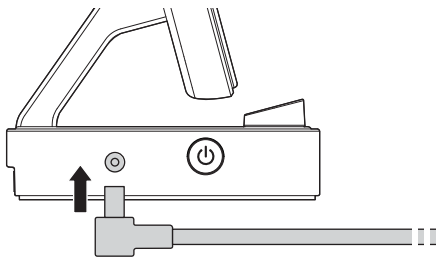

2

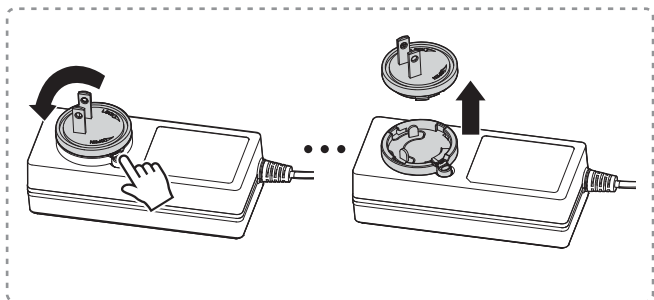
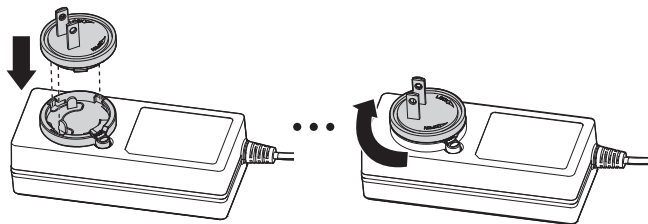

**3**

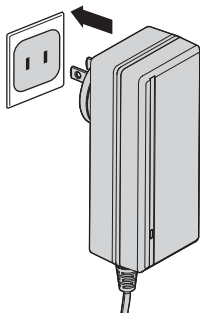

**NA**

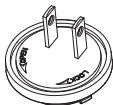

**AU**



**UK**

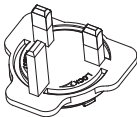

**EU**

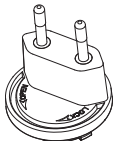

4

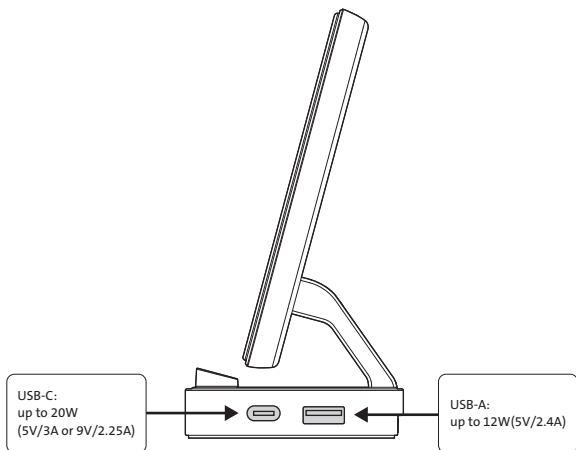
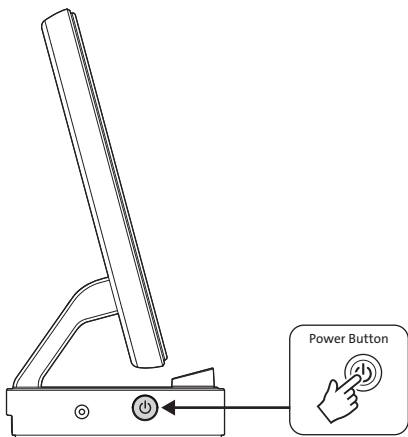

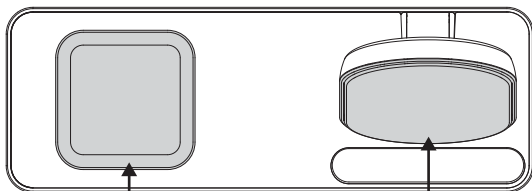

Up to 7.5W for iPhone fast charging.  
Up to 10W for Android phone  
(varied by phone).

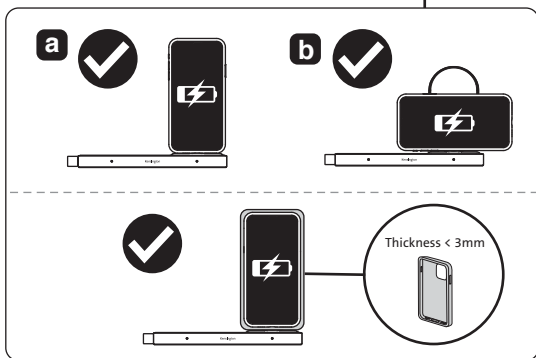
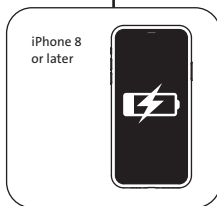

5

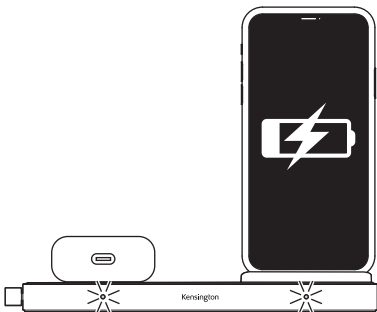
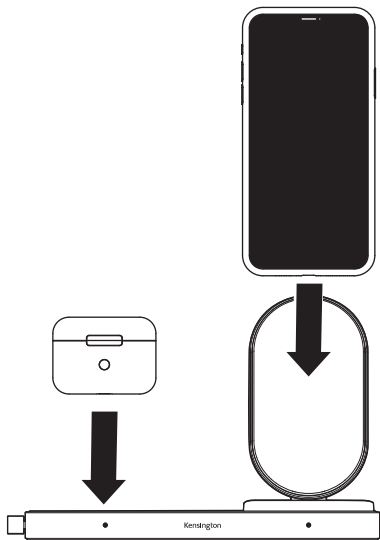

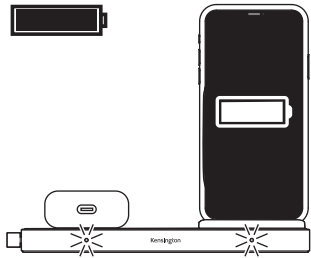
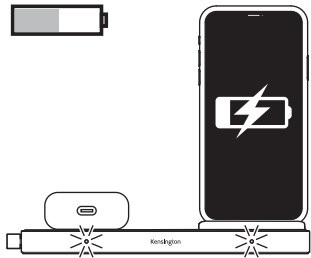
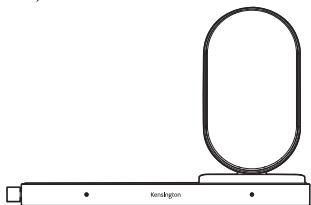

6

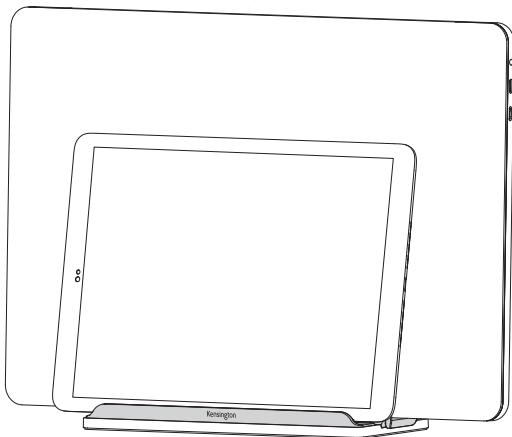
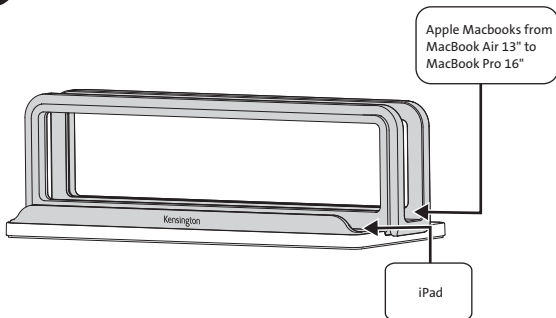



7

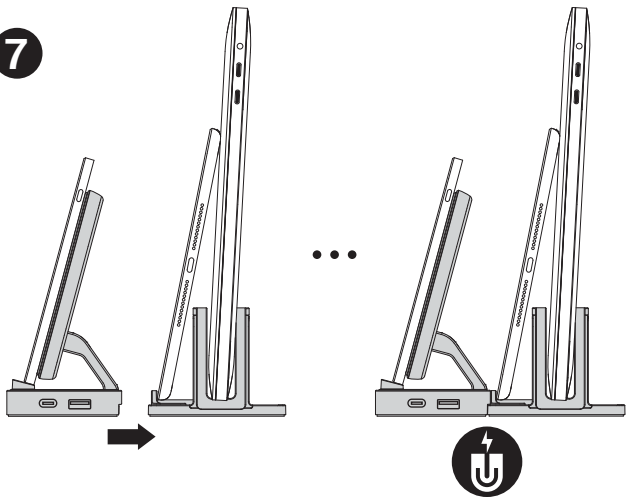

8

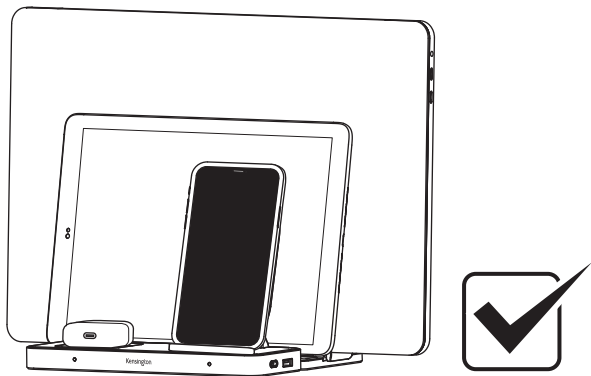

**a**

iPhone 8 Plus  
iPhone XR  
iPhone XS Max  
iPhone 11  
iPhone 11 Pro Max  
iPhone 12  
iPhone 12 Pro  
iPhone 12 Pro Max

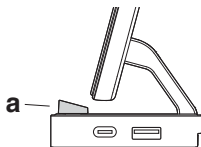
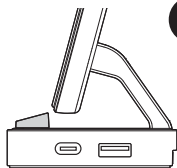
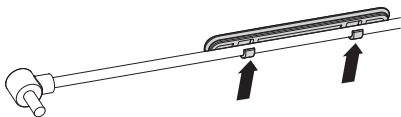
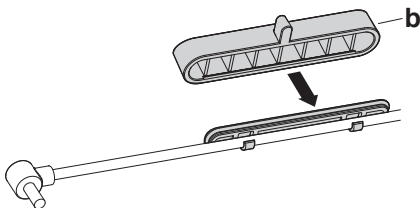
**1****a****2****3**

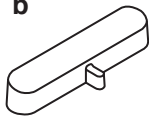
**b**

iPhone 8  
iPhone X  
iPhone XS  
iPhone 11 Pro  
iPhone SE 2020  
iPhone 12 Mini

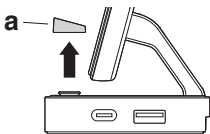
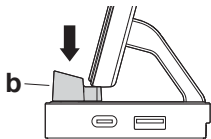
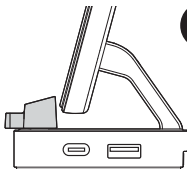
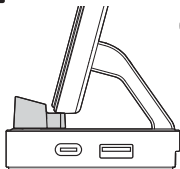
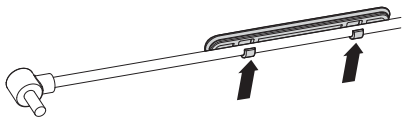
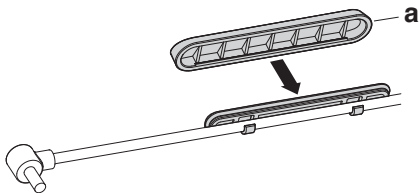
**1****2****b****3****4**

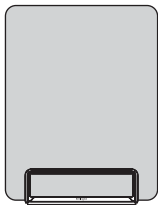
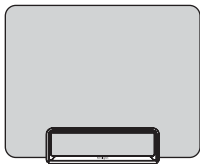
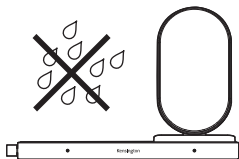
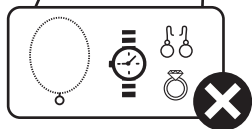
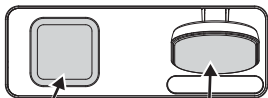

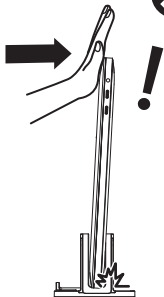
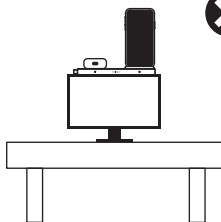
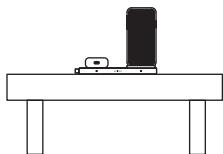
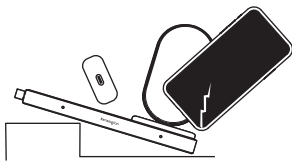
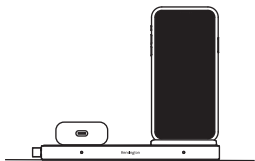

Kensington and the ACCO name and design are registered trademarks of ACCO Brands. All other registered and unregistered trademarks are the property of their respective owners. Qi is a registered trademark of Wireless Power Consortium. iPad, AirPods, and iPhone are trademarks of Apple Inc., registered in the U.S. and other countries.  
 ©2021 Kensington Computer Products Group, a division of ACCO Brands. Any unauthorized copying, duplicating, or other reproduction of the contents hereof is prohibited without written consent from Kensington Computer Products Group. All rights reserved. 02/21



**Kensington Computer Products Group**  
 A Division of ACCO Brands  
 1500 Fashion Island Blvd, 3rd Floor  
 San Mateo, CA 94404, USA

**Importer:**

ACCO UK Ltd.  
 Oxford House, Oxford Road  
 Aylesbury, Buckinghamshire,  
 HP21 8SZ  
 United Kingdom

**ACCO Brands Canada Inc**

7381 Bramalea Rd  
 Mississauga, ON L5S 1C4  
<https://accobrandscanada.com/>

**ACCO Brands Australia - Kensington**

2 Coronation Avenue  
 Kings Park NSW 2148  
 Australia

**Importer:**

LEITZ ACCO Brands GmbH & Co KG  
 Siemensstraße 64  
 70469 Stuttgart  
 Germany

**Importado e Distribuído por:**

Tilibra Produtos De Papelaria Ltda.  
 CNPJ: 44.990.901/0001-43  
 Rua Aymorés, 6-9 – Bauru/SP – Brasil  
 CEP 17013-900  
[sac@tilibra.com.br](mailto:sac@tilibra.com.br)

**Dystrybutor:**

Esselte Polska Sp. z o.o., ul.  
 Przemysłowa 11A, 26-900  
 Koźienice

**ACCO Brands Chile S.A.,**

Avda. Presidente Riesco # 5711,  
 oficina 201  
 Las Condes, Santiago, Chile  
 CP 7561114  
[www.accobrand.cl](http://www.accobrand.cl)

**Distributor:**

Esselte Sales SRL,  
 Gheorghe Țițeica 121C,  
 Sector 2, București,  
 România

**Distribútor:**

Esselte, s.r.o., V Lužich 818,  
 142 00 Praha 4,  
 Česká republika

**Forgalmazza:**

Esselte Kft, Váci út 76. V. torony  
 I. emelet,  
 1133 Budapest,  
 Magyarország

**ДИСТРИБЬЮТОР:**

Esselte Polska Sp. z o.o., ul.  
 Przemysłowa 11A, 26-900  
 Koźienice  
 Импорттаушы: "АБДИ Компани" АҚ,  
 Алматы қ., Сейфуллин даңғ. 465/191

**Дистрибутор:**

Есселте Польска Сп. з о.о., вулиця  
 Пшемислова, 11А, 26-900 Коженіц

**Импортер:**

ООО «Эсселте», Россия,  
 125040, Москва, 3-я улица  
 Ямского поля, д.18, тел.  
 +7(495)933-27-63

**アコブランドズジャパン株式会社**

〒164-8721  
 東京都中野区本町1-32-2  
 ハーモニータワー14F  
<https://www.kensington.com/ja-jp>  
 E-MAIL: [JP.Kensington@acco.com](mailto:JP.Kensington@acco.com)

广州市爱珂贸易有限公司  
 广州市天河区林和西路159号  
 中泰国际北塔5楼, 501/701室  
 邮编: 510620  
 电话: 400 600 4599

网址: <https://www.kensington.com/zh-cn>  
 邮箱: [infocn@kensington.com](mailto:infocn@kensington.com)