

Kensington®

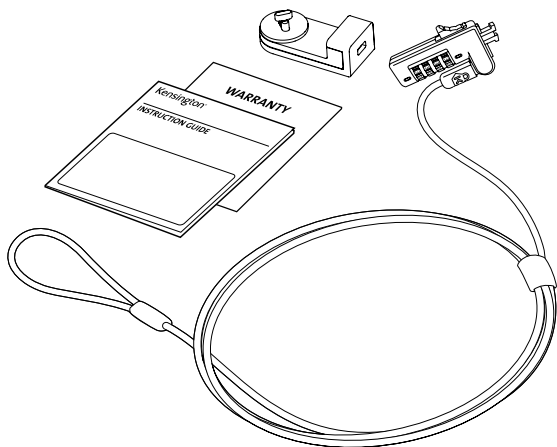

Mac Studio Locking Kit



kensington.com/register

1

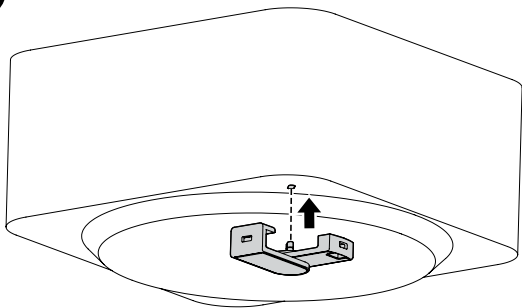

2

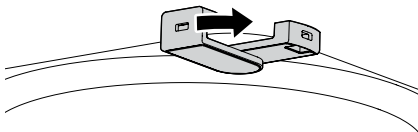

3

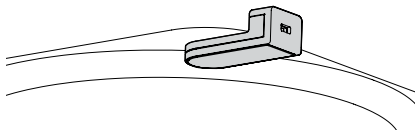



4

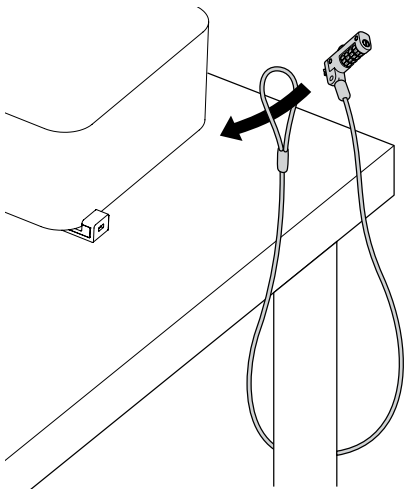

5

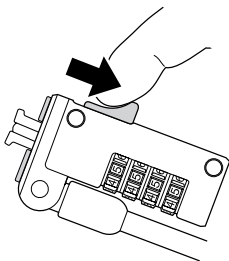

6

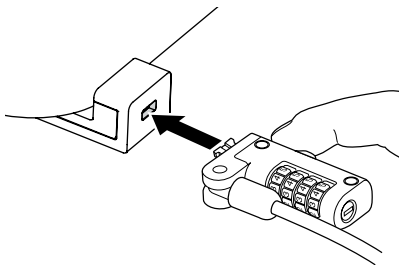

7

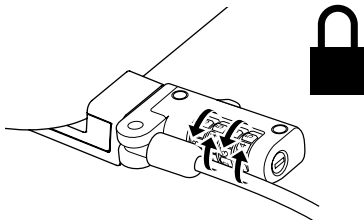

8

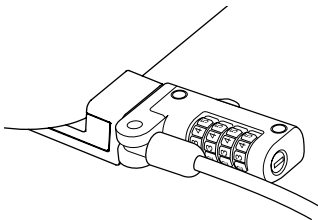



1

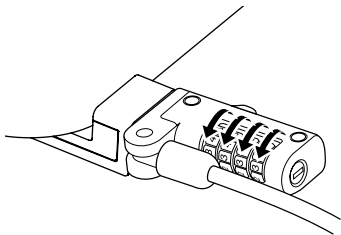

2

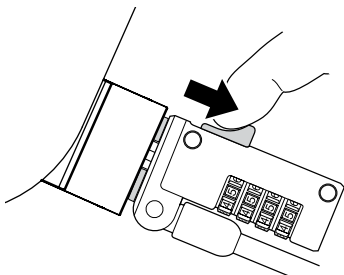

3

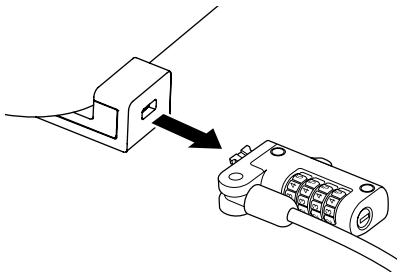

GB Reset combination	PL Ustawienie resetowania
DE Zahlenkombination zurücksetzen	CZ Resetovat kombinaci
FR Réinitialiser la combinaison	SK Vynulovať kombináciu
NL Combinatie opnieuw instellen	HU Kombinációk alaphelyzetbe állítása
ES Restablecer combinación	RO Resetați combinația
IT Combinazione reimpostata	RU Сброс комбинации
PT Reinicializar combinação	UA Скинути комбінацію
DK Nulstil kombination	KZ Комбинацияны қайта орнату
NO Tilbakestill kombinasjonslåsen	TR Kombinasyonu sıfırla
SE Återställ kombination	GR Επαναφορά συνδυασμού
FI Nollaa yhdistelmä	CN 重置组合
EE Kombinatsiooni lähtestamine	JP 組み合わせをリセット
LV Atjaunot kombināciju	AE إعادة ضبط المجموعة
LT Atstatyti kombinaciją	

1

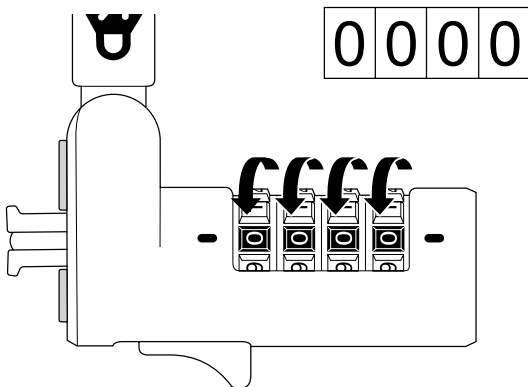

2

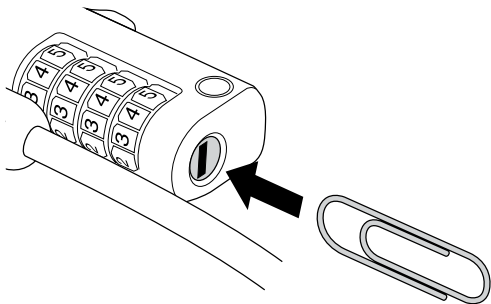

3

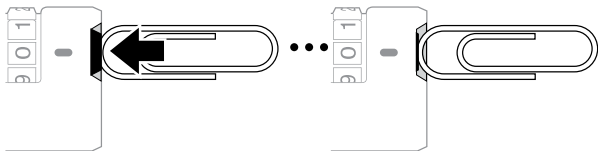

4

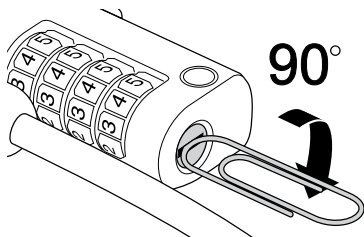

5

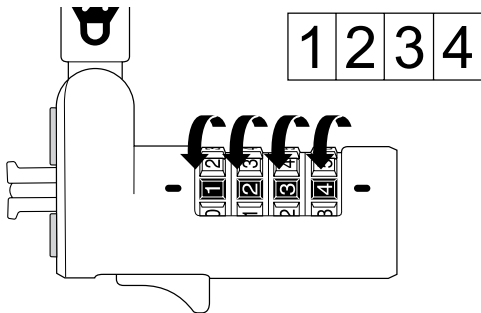

6

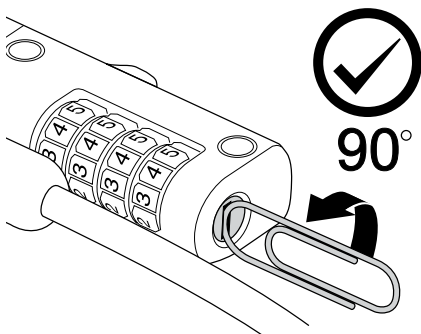

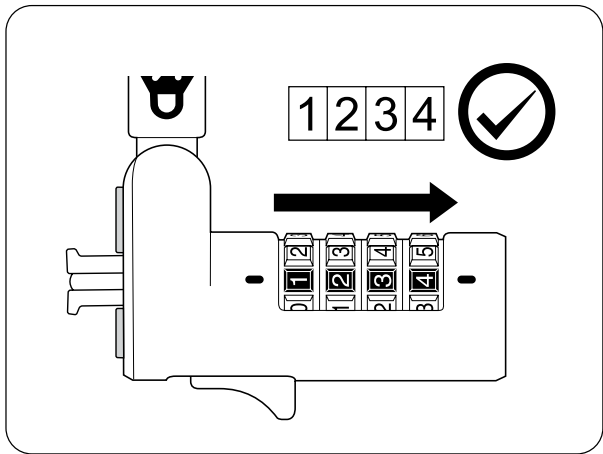



www.kensington.com/support

Kensington and the ACCO name and design are registered trademarks of ACCO Brands. All other registered and unregistered trademarks are the property of their respective owners.
©2022 Kensington Computer Products Group, a division of ACCO Brands.

