

# Kensington®

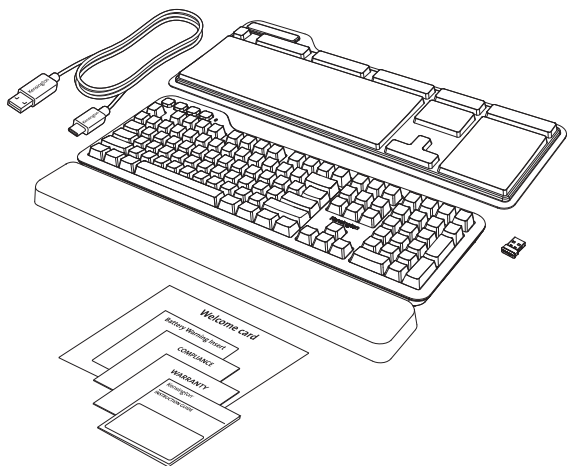

## MK7500F QuietType™ Pro Silent Mechanical Keyboard – Wireless (Full)



[kensington.com/register](https://www.kensington.com/register)

1

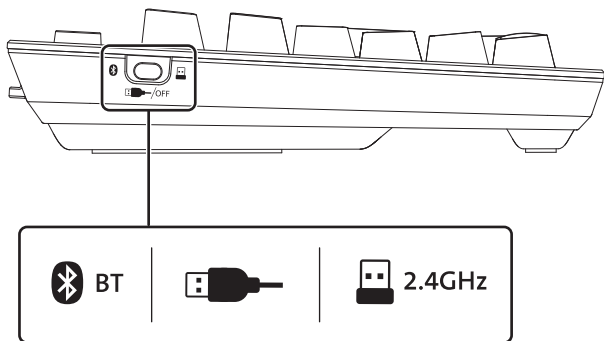

2

 2.4GHz

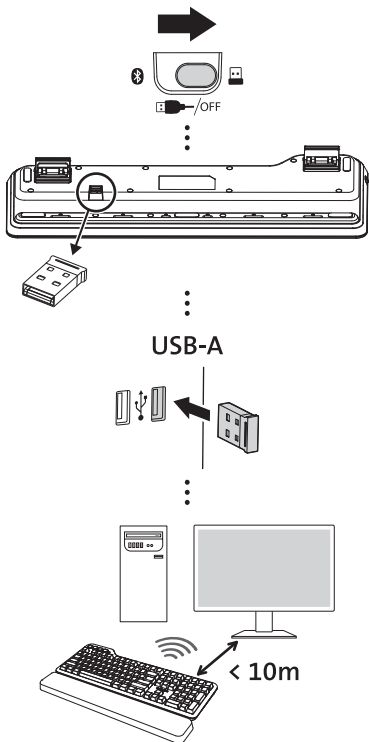



**a**

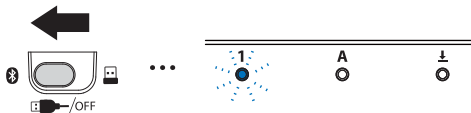

**b**

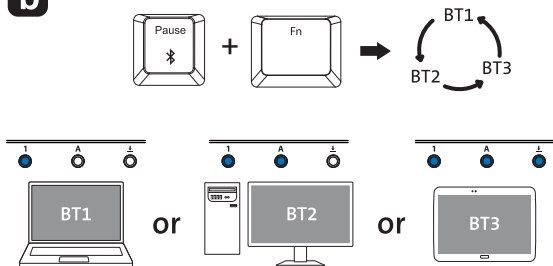

Show the current channel | Afficher la chaîne actuelle |  
Aktuellen Kanal anzeigen | Mostra il canale corrente |  
Mostrar el canal actual | Mostrar o canal atual |  
إظهار القناة الحالية | 現在のチャンネルを表示する |  
显示当前信号通道 |

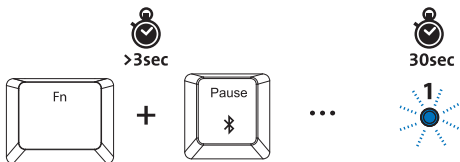
**c**

Bluetooth pairing mode | Mode d'appairage Bluetooth |  
 Bluetooth-Kopplungsmodus |  
 Modalità di associazione Bluetooth |  
 Modo de vinculación Bluetooth |  
 Modo de emparelhamento por Bluetooth |  
 وضع اقتران البلوتوث | Bluetoothペアリングモード |  
 蓝牙配对模式 |

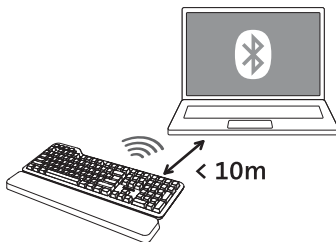
**d****e**



**a**



**b**

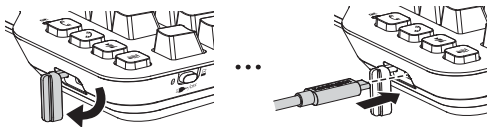

**c**

USB-A

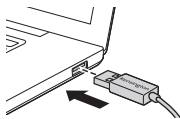

**d**

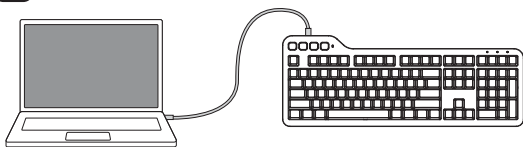

3

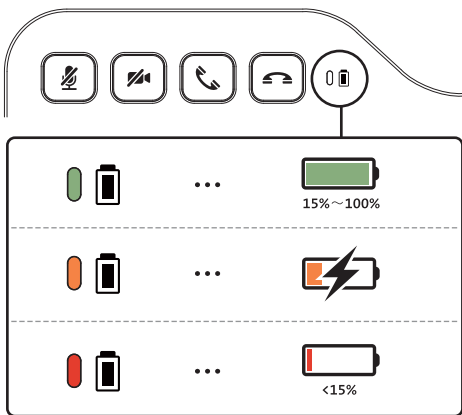
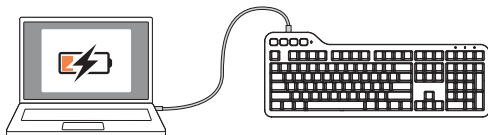
 (<15%)

Requires a minimum of 5V/1A (5W) of USB power to properly charge the keyboard. | Nécessite une alimentation USB de minimum 5 V/1 A (5W) USB pour correctement charger le clavier. | Zum ordnungsgemäßen Aufladen der Tastatur ist ein USB-Anschluss mit einer Ausgangsleistung von mindestens 5 V/1 A (5 W) erforderlich. | Per caricare correttamente la tastiera, è necessaria un'alimentazione USB di almeno 5 V/1 A (5 W). | Requiere una alimentación USB de un mínimo de 5 V / 1 A (5 W) para cargar el teclado adecuadamente. | Requer um mínimo de 5 V/1 A (5 W) de potência USB para carregar corretamente o teclado. |

يتطلب ما لا يقل عن 5 فولت/1 أمبير (5 واط) من طاقة USB لشحن لوحة المفاتيح بشكل صحيح. | キーボードを正しく充電するには、5V/1A (5W) 以上のUSB電力が必要です。 | 为键盘充电至少需要最低 5V/1A (5W) 的USB 电源。 |

4



Mute On/Off | Mode muet activé/désactivé |  
Stummschaltung ein/aus | Attivazione/disattivazione  
dell'audio | Silenciar/Activar sonido | Silenciar/Colocar som |  
تشغيل/إيقاف تشغيل كتم الصوت | ミュートオン/オフ | 静音开/关 |



Camera On/Off | Caméra activée/désactivée | Kamera  
ein/aus | Attiva/disattiva telecamera | Cámara encendida/  
apagada | Ligar/Desligar câmara | تشغيل/إيقاف تشغيل الكاميرا |  
カメラオン/オフ | 相机开/关 |



Answer Call | Répondre à l'appel | Anruf annehmen |  
Accetta chiamata | Responder llamada | Atender chamada |  
الرد على مكالمة | 着信への応答 | 应答呼叫 |



End Call | Mettre fin à l'appel | Anruf beenden | Termina  
chiamata | Finalizar llamada | Terminar chamada |  
إنهاء المكالمة | 通話の終了 | 结束呼叫 |





To customize your keyboard further, download Kensington Connect™ for Keyboards. |  
Pour personnaliser davantage votre clavier, téléchargez Kensington Connect™ pour  
claviers. | Um Ihre Tastatur weiter anzupassen, laden Sie Kensington Connect™ für  
Tastaturen herunter. | Per personalizzare ulteriormente la propria tastiera, scaricare  
Kensington Connect™ per tastiere. | Descargue Kensington Connect™ para teclados  
para personalizar el teclado. | Para personalizar ainda mais o seu teclado, transfira o  
Kensington Connect™ para teclados. |

إجراء مزيد من التخصيص للوحة المفاتيح لديك، قم بتنزيل Kensington Connect™ للوحات المفاتيح. |  
キーボードをさらに細かくカスタマイズするには、キーボードにKensington Connect™  
をダウンロードしてください。 | 如要进一步自定义键盘，请为键盘下载 Kensington Connect™。 |

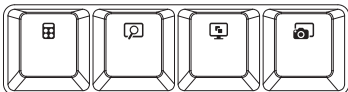

## 5



|   | Windows   | Mac |
|---|---|-----|
|    | Calculator   Calcolatrice  <br>Taschenrechner   Calcolatrice  <br>Calculadora   Calculadora  <br>الآلة الحاسبة   計算機   計算器  | *   |
|    | Search   Chercher   Suche   Ricerca   Buscar   Procurar   بحث  <br>検索   搜索  |     |
|    | Show Desktop   Afficher le bureau   Desktop anzeigen  <br>Mostra desktop   Mostrar escritorio   Mostrar Ambiente de<br>Trabalho   إظهار سطح المكتب   デスクトップを表示   显示桌面 |     |
|  | Screen Shot   Capture d'écran   Screenshot   Screenshott  <br>Captura de pantalla   Captura de ecrã   لقطة شاشة  <br>スクリーンショット   截屏                                   |     |

\*Requires Kensington Connect | \*Nécessite Kensington Connect |  
 \*Erfordert Kensington Connect | \*Richiede Kensington Connect |  
 \*Requiere Kensington Connect | \*Requer o Kensington Connect |  
 Kensington Connect تتطلب\* | \*Kensington Connectが必要 | \*需使用 Kensington Connect |

6

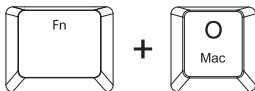
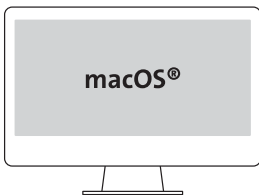
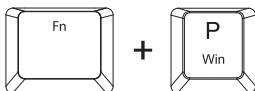
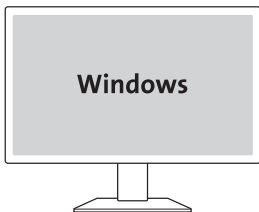

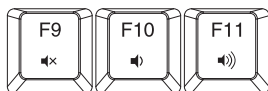
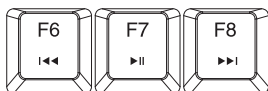

|                                |  |
|--------------------------------|--|
| <p><b>Fn + F6</b><br/> ◀◀</p>  | <p>Back   Face arrière   Rückseite   Indietro   Atrás   Retroceder  <br/>اللوحة الخلفية   バック   后退  </p>   |
| <p><b>Fn + F7</b><br/>▶  </p>  | <p>Play/Pause   Lecture/Pause   Abspielen/Pause   Riproduci/Pausa  <br/>Reproducir/Pausar   Reproduzir/Colocar em Pausa  <br/>تشغيل/إيقاف مؤقت   再生/一時停止   播放/暂停  </p>   |
| <p><b>Fn + F8</b><br/>▶▶ </p>  | <p>Forward   Commande d'avance   Vorwärts   Avanti   Adelante  <br/>Avançar   التالي   フォワード   前进  </p>  |
| <p><b>Fn + F9</b><br/>◻x</p>   | <p>Mute Speaker   Désactiver le haut-parleur   Lautsprecher<br/>stummschalten   Disattivazione dell'altoparlante  <br/>Silenciar altavoz   Silenciar altafalante   كتم صوت السماعات  <br/>スピーカーをミュートする   扬声器静音  </p> |
| <p><b>Fn + F10</b><br/>◻)</p>  | <p>Decrease Volume   Réduire le volume   Lautstärke verringern  <br/>Diminuzione del volume   Bajar volumen   Diminuir volume  <br/>خفض مستوى الصوت   音量を下げる   调低音量  </p>  |
| <p><b>Fn + F11</b><br/>◻))</p> | <p>Increase Volume   Augmenter le volume   Lautstärke erhöhen  <br/>Aumento del volume   Subir volumen   Aumentar volume  <br/>رفع مستوى الصوت   音量を上げる   调高音量  </p>   |

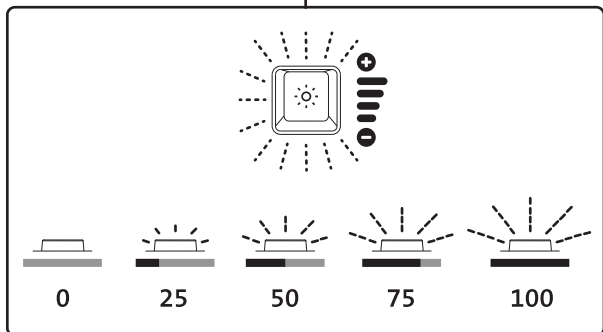
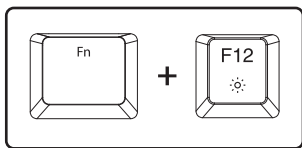

# K

- EN** Download Kensington Connect™ today: [www.Kensington.com/Konnect](http://www.Kensington.com/Konnect)
- DE** Kensington Connect™ noch heute herunterladen: [www.Kensington.com/Konnect](http://www.Kensington.com/Konnect)
- FR** Téléchargez Kensington Connect™ dès aujourd'hui : [www.Kensington.com/Konnect](http://www.Kensington.com/Konnect)
- IT** Scarica subito Kensington Connect™: [www.Kensington.com/Konnect](http://www.Kensington.com/Konnect)
- ES** Descargue ya Kensington Connect™: [www.Kensington.com/Konnect](http://www.Kensington.com/Konnect)
- PT** Descarregue hoje o Kensington Connect™: [www.Kensington.com/Konnect](http://www.Kensington.com/Konnect)
- AE** بادر بتنزيل برنامج Kensington Connect™ اليوم: [www.Kensington.com/Konnect](http://www.Kensington.com/Konnect)
- CN** 立即下载 Kensington Connect™: [www.Kensington.com/Konnect](http://www.Kensington.com/Konnect)
- JP** 今すぐKensington Connect™ をダウンロードしてください : [www.Kensington.com/Konnect](http://www.Kensington.com/Konnect)



Looking for support? Visit us online at:  
<http://kensington.com/QuietType-KeyBoard-Support>



Kensington® and QuietType™ are trademarks of ACCO Brands. macOS is a trademark of Apple Inc. registered in the U.S. and other countries. Windows is a registered trademark of Microsoft Corporation in the U.S. and/or other countries. The Bluetooth word mark and logos are registered trademarks owned by Bluetooth SIG, Inc. and any use of such marks by Kensington Computer Products Group is under license. All other registered and unregistered trademarks are the property of their respective owners.

© 2023 Kensington Computer Products Group, a division of ACCO Brands.

Patents: <https://www.accobrand.com/patents/>