

TruSens™

Z-2000

Welcome to clean air with TruSens. Thank you for allowing us to join you on your journey towards wellness.

The air you breathe should be clean, no matter where you are in the room. TruSens SensorPod™, PureDirect™ Technology & DuPont™ Filtration ensure the whole room benefits from cleaner air.

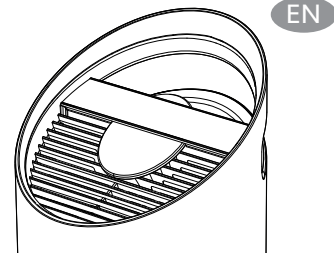

! IMPORTANT: Before operation of purifier, follow the steps and read our TruSens Owner's Guide at www.trusens.com/z-2000

Included in your box

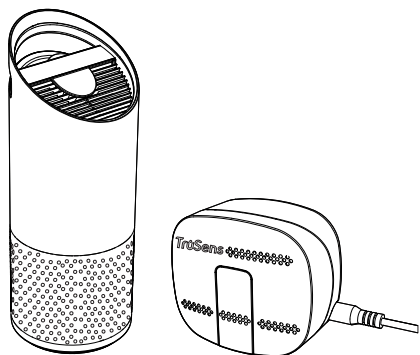

- 1 Air Purifier + Power Cord
- 1 SensorPod™ + Power Cord

! 1) Remove plastic bag from filter

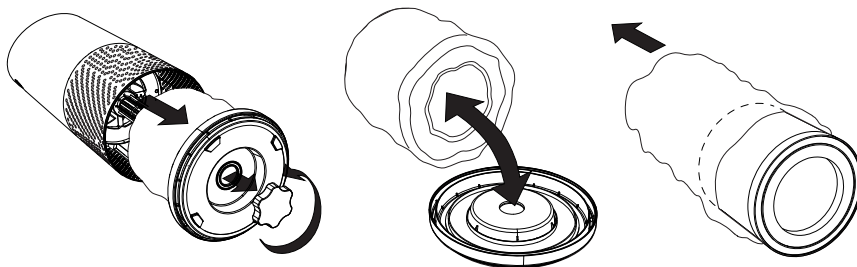

Unscrew bottom cover and remove plastic bag from filter.

2) Re-attach filter

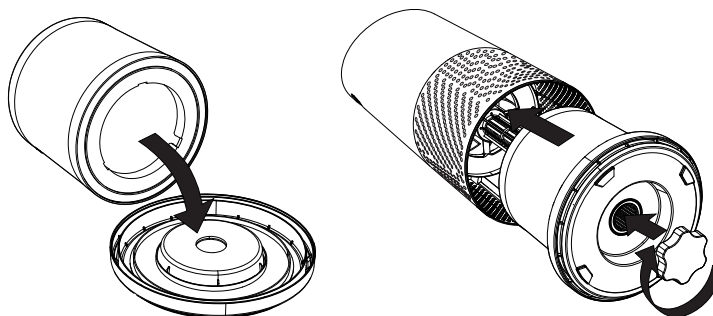

Secure filter on bottom cover and replace inside the purifier.

3) Set up

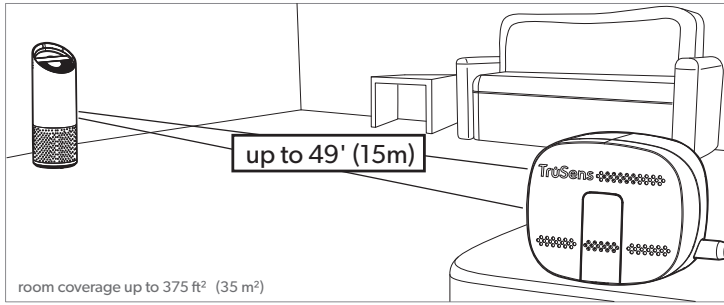

Plug-in your air purifier unit and power on.

Plug-in your SensorPod™.

For optimal results, place SensorPod™ on tabletop or counter across the room, within line of sight of the purifier.

Signal strength may vary by location.

Filter Replacement

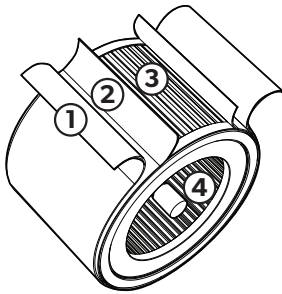

	Filter Type	Suggested Replacement/Cleaning	Item Number
①	Washable Prefilter	Hand wash as needed with water	Not sold separately, see HEPA Drum Filter
②	Carbon Filter	Every 3 - 4 months*	AFC-Z2000-01 (3-pack)
③	HEPA Drum Filter	Every 12 - 15 months*	AFH-Z2000-01 (includes ① ② and ③)
④	UV Bulb	Every 2 - 3 years*	UVL-Z2000-01

*Replacement indicator will glow red on control panel to notify you to change

Control Panel

- | Power on/off
- | Fan speed : Auto/Whisper/1/2/Turbo
- | Dimmer on/off
- | Timer : 2h/4h/8h/12h
- UV** | UV mode on/off
- Reset** | Carbon/HEPA/UV replacements

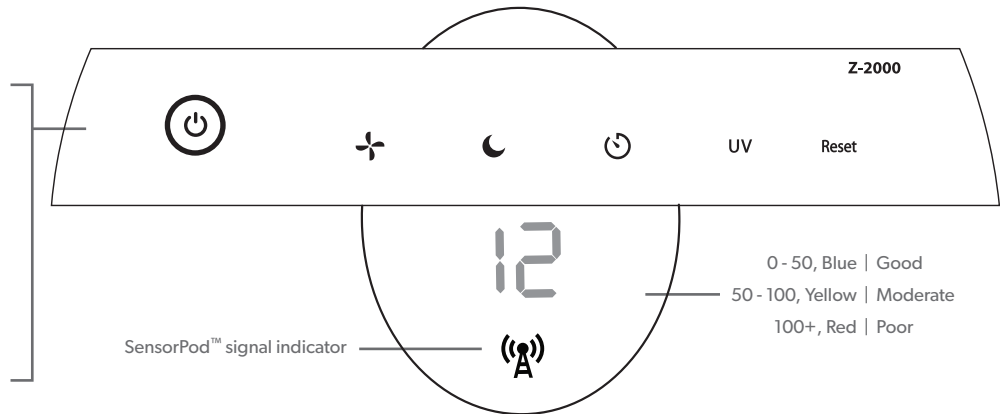

- 0 - 50, Blue | Good
- 50 - 100, Yellow | Moderate
- 100+, Red | Poor