

# Kensington®

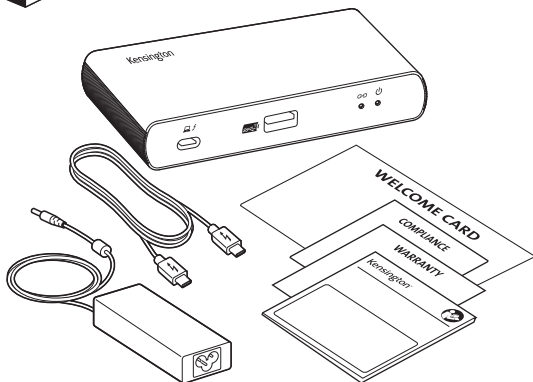

## SD2600T Thunderbolt™ 4 Nano Dock



NA



EU



UK



AP



JP



[kensington.com/register](https://www.kensington.com/register)

1

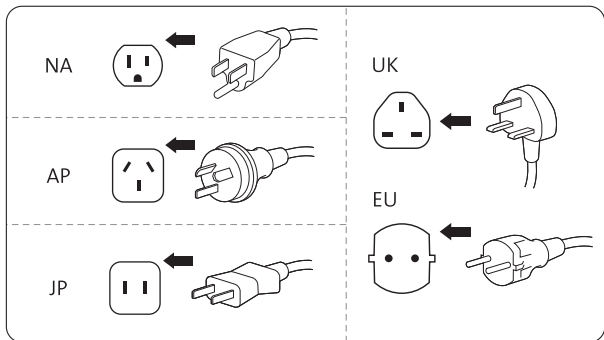
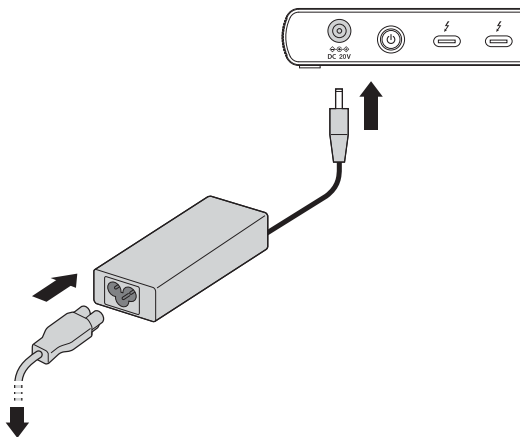

2

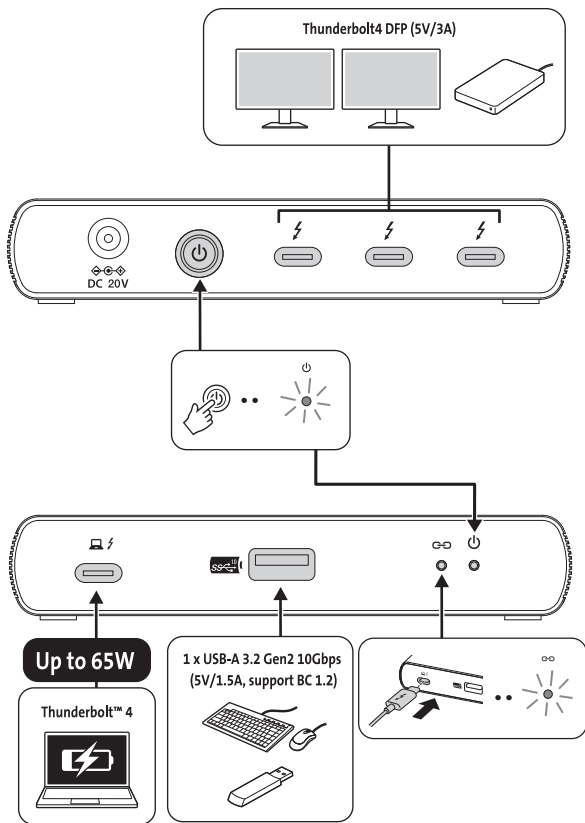

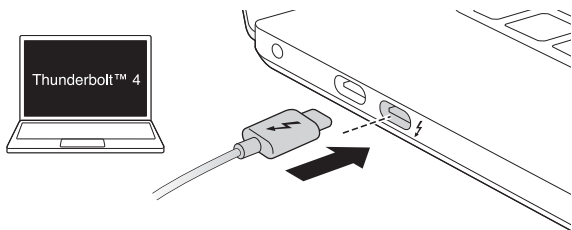

3



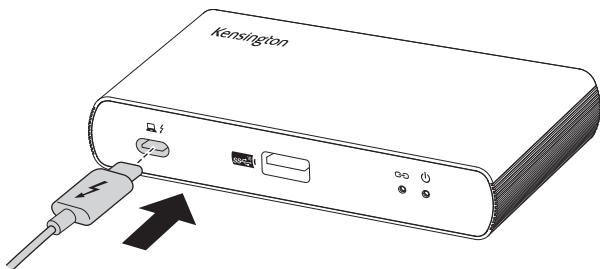

4



## 5

		
Thunderbolt™ 3 / Thunderbolt™ 4 / USB4 (Windows)	8K (7680 x 4320) @ 60Hz*	4K (3840 x 2160) @ 60Hz
Thunderbolt™ 3 / Thunderbolt™ 4 / USB4 (macOS)	6K (6016 x 3384) @ 60Hz	4K (3840 x 2160) @ 60Hz
MacBook M-series Pro / Max	6K (6016 x 3384) @ 60Hz	6K (6016 x 3384) @ 60Hz*
USB-C Alt Mode (Windows)	4K (3840 x 2160) @ 60Hz	
iPad & MacBook M-series	6K (6016 x 3384) @ 60Hz	

\*Support for Display Stream Compression (DSC) is based on the host device and monitor capabilities

		
Thunderbolt™ 3 / Thunderbolt™ 4 / USB4 (Windows)	4K (3840 x 2160) @ 120Hz or 1440p (2560 x 1440) @ 240Hz	1080p (1920 x 1080) @ 120Hz

## 6

## Initial Thunderbolt™ 4 connection for Windows

**New Thunderbolt™ device have been attached**

Thunderbolt™ devices were attached. In order to approve them for use this application must be run with administrator privileges.

Click OK to run the **Thunderbolt™** software with administrator privileges.

OK

Cancel

**6.1** Manage Thunderbolt™ 4 devices and settings later**6.2**

View Attached Devices  
Approve Attached Devices ›  
Manage Approved Device

Settings  
Exit





[www.kensington.com/support](http://www.kensington.com/support)

Kensington and the ACCO name and design are registered trademarks of ACCO Brands. All other registered and unregistered trademarks are the property of their respective owners.  
©2022 Kensington Computer Products Group, a division of ACCO Brands.

