

# Kensington®

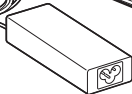

## SD5700T Thunderbolt™ 4 Dual 4K Dock

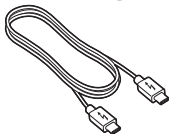
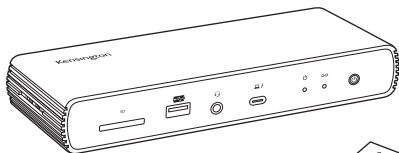

NA

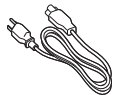

EU



AP/JP



[kensington.com/register](https://www.kensington.com/register)

1

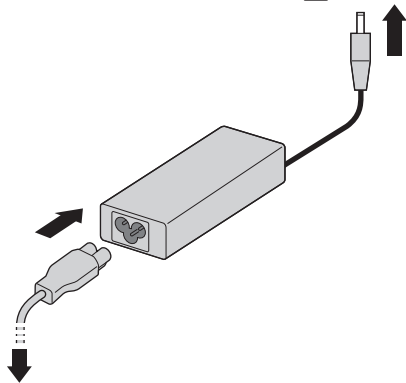
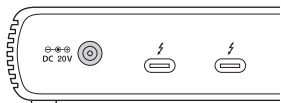

US



UK

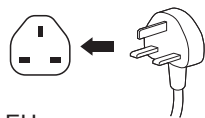

AU



EU

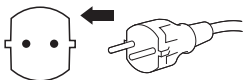

JP

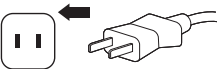

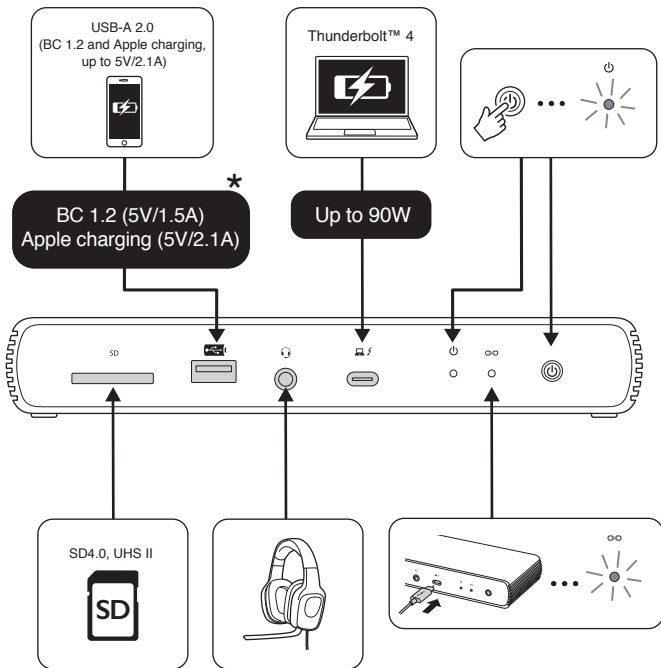

\* USB Battery Charging 1.2-compliant devices

USB-A 3.2 Gen2 / 10 Gbps (5V/0.9A)

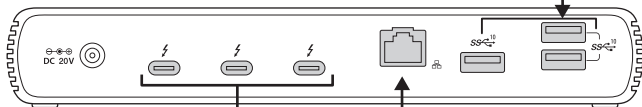
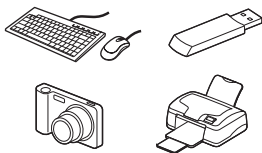

Thunderbolt4 DFP (5V/3A)



10/100/1000Mbps



3

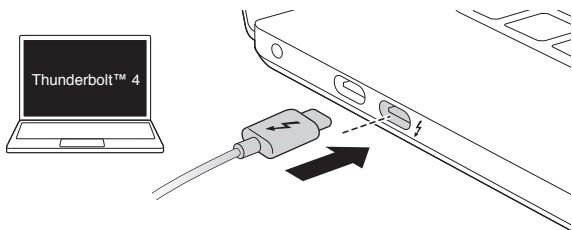

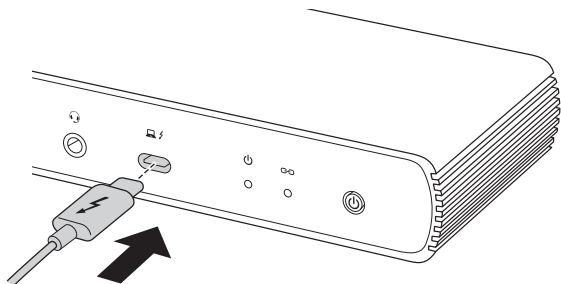

4

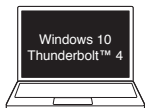

## 5



	1X 	2X 
Thunderbolt™ 4 (DSC enable)	8K@60Hz*	4K@60Hz
Thunderbolt™ 4 (DSC disable)	8K@30Hz	

\* Support for Display Stream Compression (DSC) is based on the host device's capabilities.

## 6 Initial Thunderbolt™ 4 connection for Windows

### New Thunderbolt™ device have been attached

Thunderbolt™ devices were attached. In order to approve them for use this application must be run with administrator privileges.

Click OK to run the Thunderbolt™ software with administrator privileges.

OK

Cancel

### 6.1 Manage Thunderbolt™ 4 devices and settings later



### 6.2

View Attached Devices  
Approve Attached Devices >  
Manage Approved Device

Settings

Exit



Sold separately

1

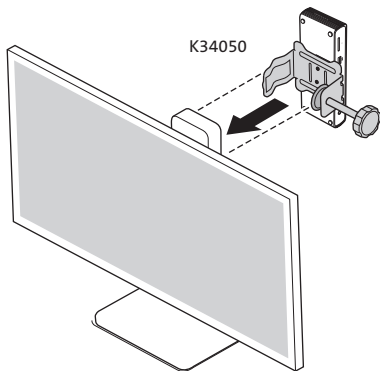

2

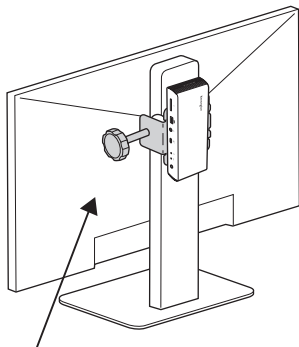

$\leq 13.2\text{lbs}$   
 $(\leq 6.0\text{kg})$



**Sold separately**

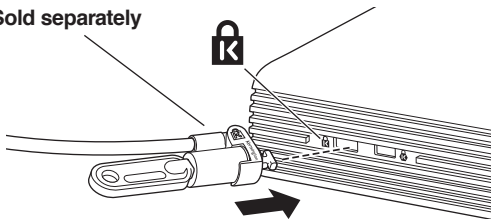

Recommended  
K65020WW MicroSaver® 2.0 Keyed Lock

**Sold separately**

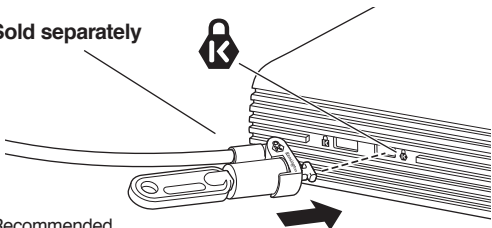

Recommended  
K64444WW NanoSaver™ Keyed Laptop Lock

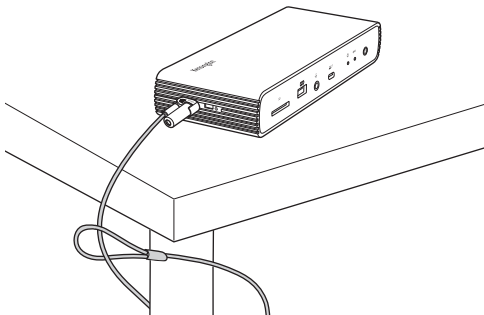

Kensington and the ACCO name and design are registered trademarks of ACCO Brands. All other registered and unregistered trademarks are the property of their respective owners.  
©2020 Kensington Computer Products Group, a division of ACCO Brands. Any unauthorized copying, duplicating, or other reproduction of the contents hereof is prohibited without written consent from Kensington Computer Products Group. All rights reserved. 10/20



**Kensington Computer Products Group**  
A Division of ACCO Brands  
1500 Fashion Island Blvd, 3rd Floor  
San Mateo, CA 94404, USA

**Importer:**

LEITZ ACCO Brands GmbH & Co KG  
Siemensstraße 64  
70469 Stuttgart  
Germany

**ACCO Brands Australia - Kensington**

2 Coronation Avenue  
Kings Park NSW 2148  
Australia

**Dystrybutor:**

Esselte Polska Sp. z o.o., ul.  
Przemysłowa 11A, 26-900  
Kozienice

**Forgalmazza:**

Esselte Kft, Váci út 76. V. torony  
I. emelet,  
1133 Budapest,  
Magyarország

**广州市爱珂贸易有限公司**

广州市天河区林和西路159号  
中泰国际北塔5楼.501/701室  
邮编: 510620  
电话: 400 600 4599  
网址: <https://www.kensington.com/zh-CN>  
邮箱: [info@kensington.com](mailto:info@kensington.com)

**Importer:**

**ACCO UK Ltd.**  
Oxford House, Oxford Road  
Aylesbury, Buckinghamshire, HP21 8SZ  
United Kingdom

**ACCO Brands Chile S.A.,**

Avda. Presidente Riesco # 5711,  
oficina 201  
Las Condes, Santiago, Chile  
CP 7561114  
[www.accobrands.cl](http://www.accobrands.cl)

**Distribuitor:**

Esselte Sales SRL,  
Gheorghe Țițeica 121C,  
Sector 2, București,  
România

**Импортер:**

ООО «Эссельте», Россия,  
125040, Москва, 3-я улица  
Ямского поля, д.18, тел.  
+7(495)933-27-63

**アコブランド・ジャパン株式会社**

〒164-8721  
東京都中野区本町1-32-2  
ハーモニータワー14F  
<https://www.kensington.com/ja-JP>  
E-MAIL: [JP.Kensington@acco.com](mailto:JP.Kensington@acco.com)

**ACCO Brands Canada Inc**

7381 Bramalea Rd  
Mississauga, ON L5S 1C4  
<https://accobrandscanada.com/>

**Importado e Distribuído por:**

Tilibra Produtos De Papelaria Ltda.  
CNPJ: 44.990.901/0001-43  
Rua Aymorés, 6-9 – Bauru/SP – Brasil  
CEP 17013-900  
[sac@tilibra.com.br](mailto:sac@tilibra.com.br)

**Distribútor:**

Esselte, s.r.o., V Lužich 818,  
142 00 Praha 4,  
Česká republika

**ДИСТРИБЬЮТЕР:**

Esselte Polska Sp. z o.o., ul.  
Przemysłowa 11A, 26-900  
Kozienice  
Импортеру: "АБДИ Компани" АҚ,  
Алматы қ., Сейфуллин даңғ. 465/191

**Дистрибутор:**

Esselte Polska Sp. z o.o., вулиця  
Шпемислова, 11А, 26-900 Козеніц