

kensington.com/register

#

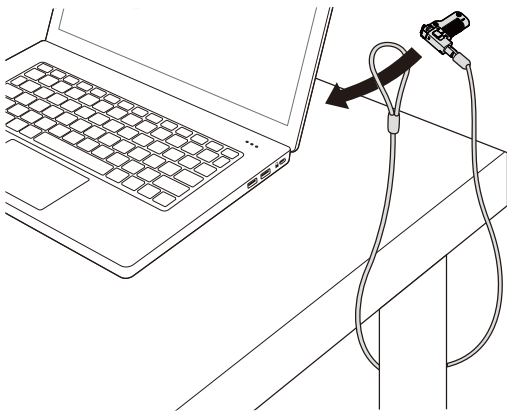

2

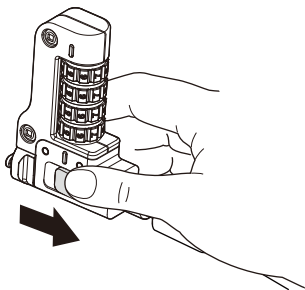

3

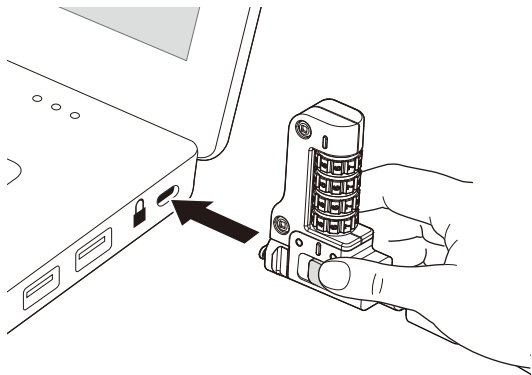

4

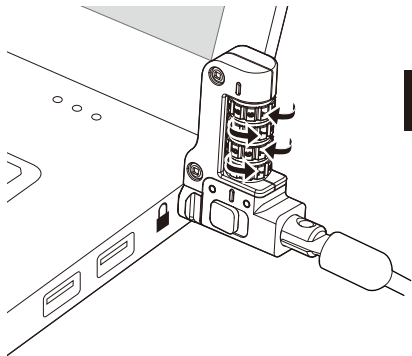

5

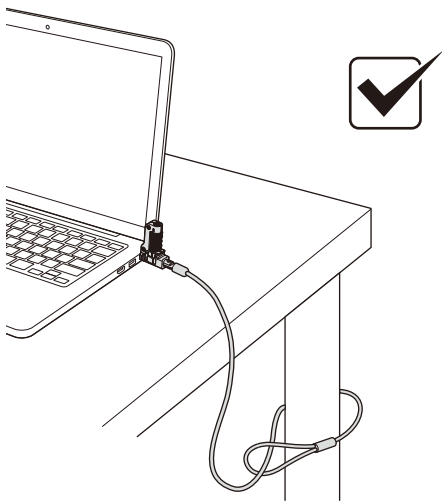

- EN** For maximum security be sure to turn all dials to a random configuration after securing the lock to your laptop.
- FR-CA** Pour une sécurité optimale, veillez à tourner tous les cadrans dans une configuration aléatoire après avoir fixé le verrou à votre ordinateur portable.
- DE** Für maximale Sicherheit stellen Sie bitte sicher, dass Sie alle Einstellräder auf eine zufällige Konfiguration gestellt haben, nachdem Sie das Schloss an Ihrem Laptop befestigt haben.
- FR** Pour une sécurité maximale, assurez-vous de régler toutes les molettes sur une position aléatoire après avoir attaché le cadenas à votre ordinateur portable.
- ES** Para mayor seguridad, asegúrese de cambiar todos los diales a una configuración aleatoria después de fijar el candado a su ordenador portátil.
- IT** Per la massima sicurezza, ruota tutti i dischi su una posizione casuale dopo aver fissato il lucchetto al portatile.
- PT** Para máxima segurança, certifique-se de rodar todos os mostradores para uma combinação aleatória depois de fechar o cadeado do seu portátil.
- CN** 为确保安全，请在锁定笔记本电脑后，将所有旋钮切换到任意配置。
- JP** 最大限のセキュリティのため、ラップトップをロックしたら、すべてのダイヤルをランダムにしてください。
- AE** لضمان أقصى قدر من الأمان، تأكد من تحويل جميع الأقراص إلى التكوين العشوائي بعد تأمين قفل الكمبيوتر المحمول.



1

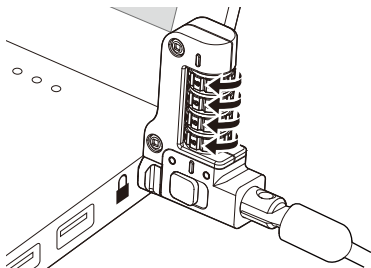

2

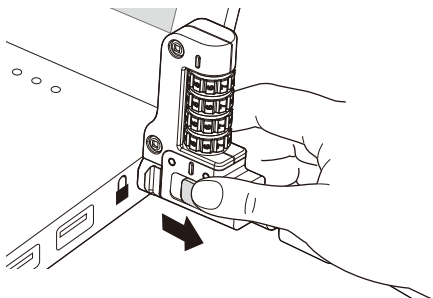

3

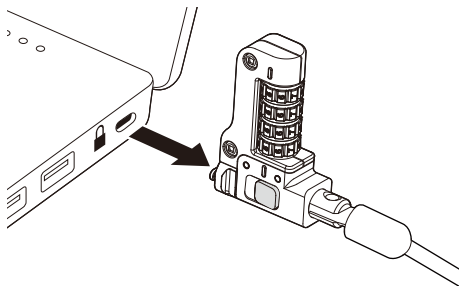



www.kensington.com/support

Kensington® is a registered trademark of ACCO Brands. USB-C® is a trademark of USB Implementers Forum. All other registered and unregistered trademarks are the property of their respective owners.

© 2025 Kensington Computer Products Group, a division of ACCO Brands.

Patents: <https://www.accobrand.com/patents/>

Kensington® est une marque déposée d'ACCO Brands. USB-C® est une marque déposée de l'USB Implementers Forum. Toutes les autres marques déposées et non déposées sont la propriété de leurs propriétaires respectifs.

© 2025 Kensington Computer Products Group, une division d'ACCO Brands.

Brevets : <https://www.accobrand.com/patents/>

